



# TECHNICAL LIGHTING

## Part III

EDITION  
**2022**  
**2023**



# WELCOME TO OUR **PRODUCT CATALOG** 2022 - 2023

## **Technisches Licht Teil III**

Im dritten Teil unserer Orange One Trilogie finden Sie unsere neuen System- und Einbauleuchten aus den Serien Omega und Luxx mit einer Auswahl schöner und zeitloser Leuchten in technisch modernem Design.

## ***Technical Light Part III***

*In the third part of our Orange One trilogy you will find our new System and Downlight lamps from the Omega and Luxx Series with a range of beautiful and timeless lamps in modern and technical design.*

# INHALT/CONTENT

## OMEGA

Übersicht/Overview	06-07
Technische Daten/Technical Facts	08-13
Narrow Beam	14-17
Standard	18-23
Premium	24-31
Zoomable	32-37
Wall Washer	38-43
Plus	42-47
Kingo	48-53

## LUXX

Round Adjustable	68-73
Square Adjustable	74-83
AGB	84-87



Deckenleuchte  
Surface-Mounted



Wandleuchte  
Wall-Mounted



Pendelleuchte  
Pendant



## OMEGA

Unbegrenzte Möglichkeiten mit der OMEGA-Familie. Sieben Versionen in einem exzellenten modularen Kombinationskonzept mit ähnlichem Erscheinungsbild, aber unterschiedlichen Lichtlösungen, die die OMEGA-Familie ausmachen, passen problemlos in jede Einzelhandels-, Museums- und Galeriumgebung. OMEGA deckt Hochleistungsakzentbeleuchtung mit sehr engem Abstrahlwinkel von 6°, verschiedene austauschbare Linsen und optische Zubehörteile, Flutlicht für Exponate, Strahlwinkelverstellung von eng bis breit, Wandfluter und Wandprojektionen ab. Neben den vielseitigen Lichtlösungen ist OMEGA auch eine komplette Familie mit verschiedenen Installationsmethoden (Stromschienenmontage, Pendelmontage, Aufputz und Wandmontage). Wenn Sie also eine Umgebung haben, in der Sie nach verschiedenen Lichtlösungen und verschiedenen Installationsmethoden suchen, ist die OMEGA-Familie eine gute Wahl, um einen einheitlichen Eindruck zu garantieren.

UNLIMITED POSSIBILITIES with OMEGA family. Seven versions in excellent modular combination concept with similar appearances but different light solutions entitle OMEGA family will fit smoothly into any retails, museums and galleries environment. OMEGA covers high performance accent lighting with very narrow beam 6°, different interchangeable beam lens & different optical accessories, flood lighting of exhibits, beam angle adjusting from narrow to wide, wall washing and projection. Except versatile light solutions, OMEGA is also a complete family with different installation methods(track-mounted, pendant, surface-mounted and wall-mounted). So, if you have an environment where ask for different light solutions & different installation methods, OMEGA family will be a great choice to get a unified impression.



## ÜBERSICHT

**Anwendung:** Schiene, Decke, Pendel, Wand  
**Lichtquelle:** Hochvolt LED/COB  
**Lichtaustritt:** Skalierbarer Strahl 6°  
Feste Linse 15°, 18°, 24°, 38°, 60°  
Zoombar 15°-45°, 25°-60°  
Projektion (20°-40°)  
Wand Fluter  
Flutlicht 15x30°, 10x60°, 30x60°  
**SDCM:** <3  
**Watt:** 10W-35W  
**Farbtemperatur:** 3000K, 4000K  
**Lumen:** 470lm-3395lm  
**Schloptionen:** an/aus, dimmbar  
**CRI:** 90+  
**Gehäusefarbe:** Weiß, Schwarz, Silber

## OVERVIEW

**Application:** Track-mounted, Pendant, Surface-mounted, Wall-mounted  
**Light source:** COB LED, High power LED  
**Light solution:** Narrow Beam 6°  
Fixed Lens 15°, 18°, 24°, 38°, 60°  
Zoomable 15°-45°, 25°-60°  
Projection (20°-40°+framing patterns)  
Wall Washing  
Flood lighting 15x30°, 10x60°, 30x60°  
**SDCM:** <3  
**Watt:** 10W -35W  
**CCT:** 3000K, 4000K  
**Luminous:** 470lm-3395lm  
**Control option:** On/off, dimmable  
**CRI:** 90+  
**Color:** White, Black, Silver

# OMEGA Übersicht/Overview

Serie Series	Narrow Beam	Standard	Premium		
Seite Page	14-17	18-23	24-31		32-37
Modell Model	Pendel Pendant				
	Wandmontage Wall-mounted				
Deckenmontage Surface-Mounted					
	Schienen- montage Track-Mounted				
Watt Lumen	10W 470lm	20W 25W 30W 1900lm 2380lm 2900lm	10W 15W 935lm 1280lm	20W 25W 30W 2350lm 2850lm 3390lm	10W 15W 695lm 1250lm
Abstrahlwinkel Beam Angle (°)	6°	15°, 24°, 36°, 60°	12°, 24°, 36°, 60°	15°, 18°, 24°, 36°, 60°	15° - 45°
Farbtemperatur Color Temperature	3.000K 4.000K	3.000K 4.000K	3.000K 4.000K	3.000K 4.000K	3.000K 4.000K
Dimmen Dimming	optional dimmbar optionally dimmable	optional dimmbar optionally dimmable	optional dimmbar optionally dimmable	optional dimmbar optionally dimmable	optional dimmbar optionally dimmable
CRI	90+	90+	90+	90+	90+
Gehäusefarbe Surface Color	Silber, Schwarz, Weiß Silver, Black, White	Silber, Schwarz, Weiß Silver, Black, White	Silber, Schwarz, Weiß Silver, Black, White	Silber, Schwarz, Weiß Silver, Black, White	Silber, Schwarz, Weiß Silver, Black, White
Optisches Zubehör Optical Accessories	8 Polaroid Filter 8 Polaroid Filters 				

Zoomable	Wall Washer		Plus	Kingo S Kingo
				
32-37	38-41		42-47	48-53
				
				
				
				
20W 1830lm 25W 2090lm 30W 2440lm	10W 730lm	20W 1675lm	35W 2830lm	18W 1659lm 30W 2490lm
25° - 60°	25°*75°	25°*75°	15°,30°,60°,80° 15°x35°,10°x60°,30°x60°	50°x50°,80°x80°,15°,20°,30°, 45°,60°,20°x40°,10°x60°
3.000K 4.000K	3.000K 4.000K	3.000K 4.000K 5.000K	3.000K 4.000K 5.000K	3.000K 4.000K
optional dimmbar optionally dimmable	optional dimmbar optionally dimmable	optional dimmbar optionally dimmable	optional dimmbar optionally dimmable	optional dimmbar optionally dimmable
90+	90+	90+	90+	90+
Silber, Schwarz, Weiß Silver, Black, White	Silber, Schwarz, Weiß Silver, Black, White	Silber, Schwarz, Weiß Silver, Black, White	Silber, Schwarz, Weiß Silver, Black, White	Silber, Schwarz, Weiß Silver, Black, White
 Honeycomb Filter			Wall Washing Lens 	

• Optiken/Optics



feste Linse/fixed lens



skalierbare Linse/zoomable lens

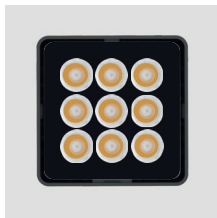

Wandfluter Linse/wall washer lens



Omega



Gut/Good Schlecht/Bad

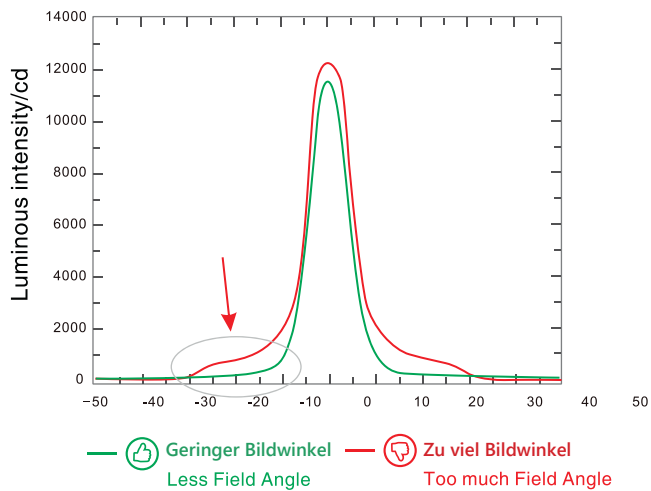
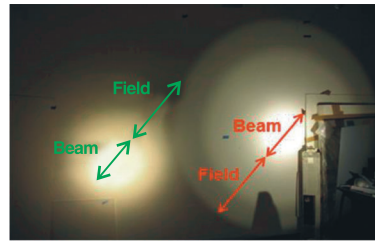

Die folgende Tabelle gibt einen Überblick über die vorgeschlagenen Strahl- und Feldwinkel für jede Anwendung in den folgenden Definitionen:

- Abstrahlwinkel =  
2 x (halber Winkel bei 50% CBCP)
- Bildwinkel =  
2 x (halber Winkel bei 10% CBCP)

The following table below gives an overview of the suggested beam and field angles for each using the following definitions:

- Beam Angle = 2 X (half angle at 50% CBCP)
- Field Angle = 2 X (half angle at 10% CBCP)

Verteilung Distribution	Strahlungswinkel Beam Angle	bevorzugter Bildwinkel Field Angle (preferred)
PunktueLLer Spot/Narrow Spot (NS)	8°	15° - 18°
Spot (SP)	15°	25° - 30°
Punktuelles Flutlicht/Narrow Flood (NF)	25°	40° - 45°
Flutlicht/Flood (FL)	45°	60° - 65°
Weites Flutlicht/Wide Flood (WF)	60°	80° - 85°
Wand Flutlicht/Wall Wash (WW)	N/A	N/A

**HINWEIS:** Obwohl der Unterschied zwischen den einzelnen Winkeln klein ist, reagiert das menschliche Auge sehr empfindlich auf schnelle Veränderungen. Bitte beachten Sie die kartesische Handlung und das Foto unten. Streulicht im Feld ist kritischer bei engen Ausstrahlungen.

**NOTE:** While the difference in field angles is small the human eye is very sensitive to rapid changes. Please reference the Cartesian plot and photograph below. Stray light in the field is more critical with narrow beams.

• Lichtlösungen/Light Solutions

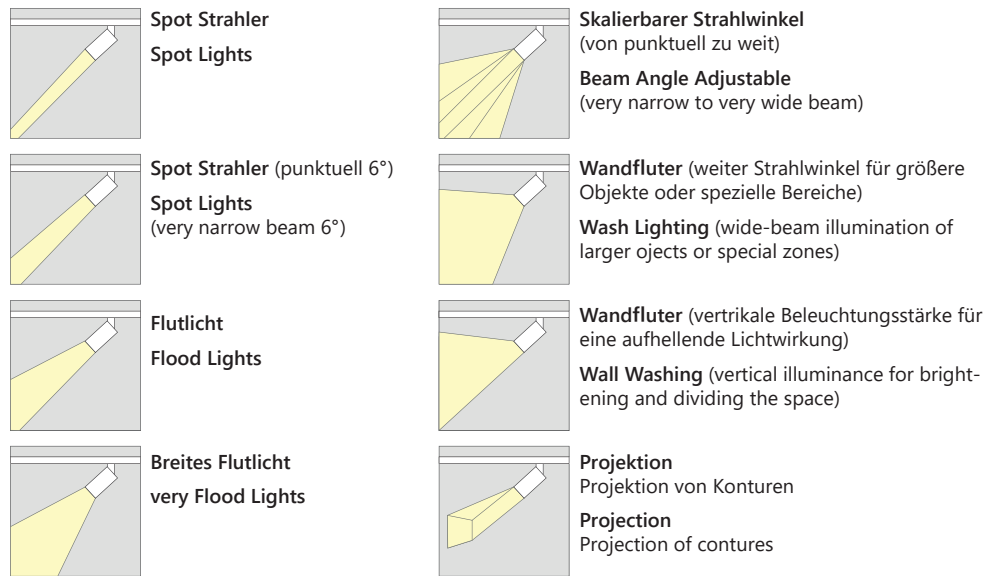

• Blendfreies Accessoire/Anti-glare Accessoires

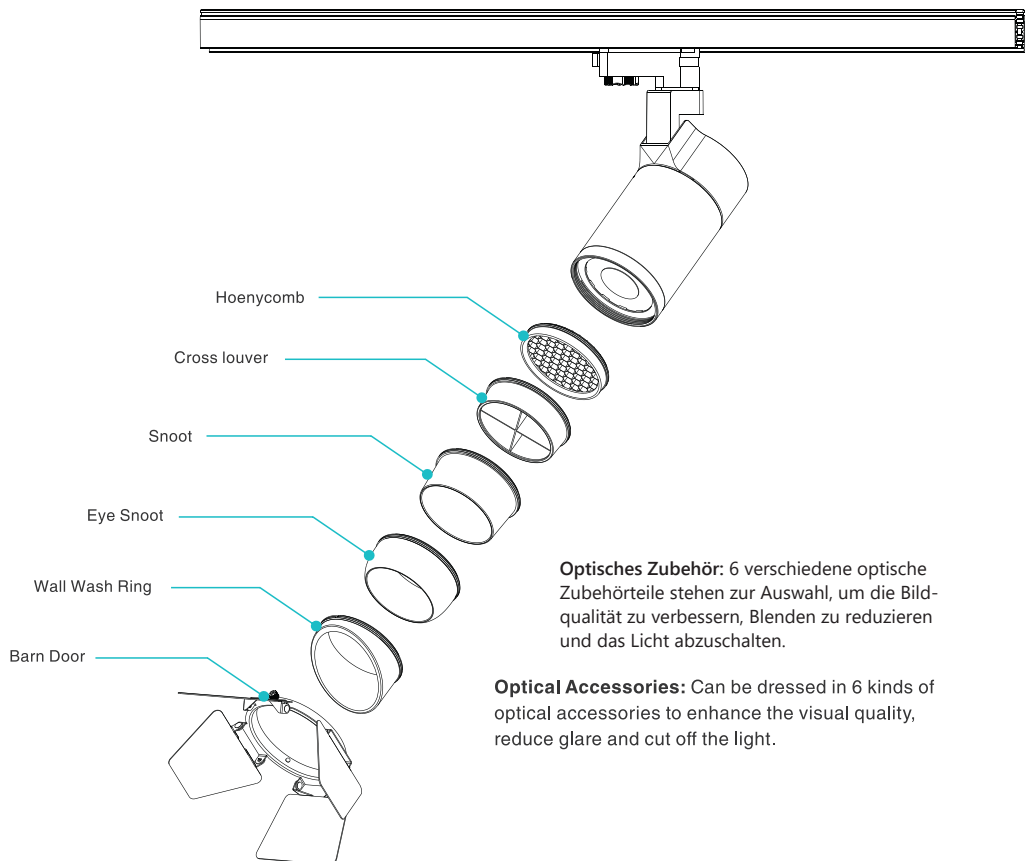

• LED

**CREE LED COB**



2.700K, 3.000, 4.000K, 5.000K  
CRI90

115° Betrachtungswinkel, gleichmäßiges Farbprofil  
Oberseitiger Lötanschluss  
Befestigungspunkt für Thermoelement  
NEMA SSL-3 2011 Standard fluxbins  
RoHS- und reichweitenkonform  
UL® anerkannte Komponente (E349212)

115° viewing angle, uniform chromaticity profile  
Top-side solder connections  
Thermocouple attach point  
NEMA SSL-3 2011 standard fluxbins  
RoHS- and reach-compliant  
UL® recognized component (E349212)

**Color Tolerance SDCM<3**

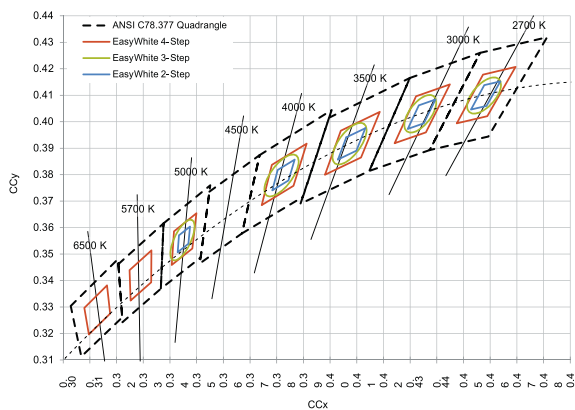

Step 2: Farbdifferenz kann nicht wahrgenommen werden  
Step 3: Schwer wahrnehmbarer Farbunterschied  
Step 4: Farbdifferenz wird wahrgenommen

Step 2: Can't perceive color difference  
Step 3: Difficult to perceive color difference  
Step 4: Can perceive color difference

**CRI**



**Ra=80**



**Ra=90**



**Ra=95**

- Led Driver Solutions

## AC200-240V Market

### Tridonic LED Driver



#### Produkt Beschreibung

- Festeingestellter Ausgang im LED-Treiber
- Konstantstrom-LED-Treiber
- Für Leuchten der Schutzklasse II
- Für Umgebungstemperatur bis 60°C
- Lebensdauer bis zu 50.000 Std (bei ta 50°C)
- 5 Jahre Garantie

#### Product description

- Fixed output built in LED Driver
- Constant current LED Driver
- For luminaires of protection class II
- For ambient temperature up to 60°C
- Nominal life-time up to 50.000 h (at ta 50°C)
- 5-year guarantee

#### Funktionen

- Überspannungsschutz
- Kurzschluss-Schutz
- Übertemperaturschutz
- Leerlaufschutz

#### Functions

- Over voltage protection
- Short-circuit protection
- Over temperature protection
- No-load protection

#### Standards

- EN 55015
- EN 61000-3-2
- EN 61000-3-3
- EN 61347-1
- EN 61347-2-13
- EN 61547-1

#### Standards

- EN 55015
- EN 61000-3-2
- EN 61000-3-3
- EN 61347-1
- EN 61347-2-13
- EN 61547-1



• Ultimativer Adapter mit verdecktem Treiber/Ultimate Adapter with concealed Driver

• **Ultimate Adapter-Base Version:**



1 circuit



3 circuit

Technische Besonderheit: Flimmerfrei  
 Input: 120V-240Vac, 50/60HZ  
 Output: 16-38 Vdc, 45 Vdc.Max.  
 PF>0.9, THD<15%  
 ta: -25°C -40°C , tc: 85°C  
 Schutz im unbelasteten Zustand: Kurzschlusschutz, Überspannungsschutz  
 Certificate: ENEC/UL/SAA/CCC

Specifications:Flicker Free  
 Input: 120V-240Vac, 50/60HZ  
 Output: 16-38 Vdc, 45 Vdc.Max.  
 PF>0.9, THD<15%  
 ta: -25°C -40°C , tc: 85°C  
 Unloaded Protection; Short-circuit Protection;  
 Overvoltage Protection; Certificate: ENEC/UL/SAA/CCC

• **Ultimate Adapter- DALI Version:**

Auf Anfrage



Technische Besonderheit: Flimmerfrei  
 Input: 120V-240Vac, 50/60HZ  
 Output: 16-38 Vdc, 45 Vdc.Max.  
 PF>0.9, THD 15%  
 ta: -25°C -40°C , tc: 85°C  
 Schutz im unbelasteten Zustand: Kurzschlusschutz, Überspannungsschutz-  
 Certificate: ENEC/UL/SAA/CCC

Specifications: Flicker Free  
 Input: 120V-240Vac, 50/60HZ  
 Output: 16-38 Vdc, 45 Vdc.Max.  
 PF>0.9, THD 15%  
 ta: -25°C -40°C , tc: 85°C  
 Unloaded Protection; Short-circuit Protection; Overvoltage Protection;  
 Certificate: ENEC/UL/SAA/CCC

**DALI connection, remote control via bluetooth 64 devices interlinking, any lighting scene as desired.**

**APP remote control**   
**Dimming Range: 5%~100%**

• **Ultimate Adapter-Zigbee Version:**

Auf Anfrage



1 circuit



3 circuit

Technische Besonderheit: Flimmerfrei  
 Input: 120V-240Vac, 50/60HZ  
 Output: 16-38 Vdc, 45 Vdc.Max.  
 PF>0.9, THD<15%  
 ta: -25°C -40°C , tc: 85°C  
 Schutz im unbelasteten Zustand: Kurzschlusschutz, Überspannungsschutz  
 Certificate: ENEC/SAA/UL/CQC/CE

Specifications: Flicker Free  
 Input: 120V-240Vac, 50/60HZ  
 Output: 16-38 Vdc, 45 Vdc.Max.  
 PF>0.9, THD<15%  
 ta: -25°C -40°C , tc: 85°C  
 Unloaded Protection; Short-circuit Protection; Overvoltage Protection;  
 Certificate: ENEC/SAA/UL/CQC/CE

**Zigbee connection; cloud remote control**  
**128 devices interlinking, any lighting scene as desired IOT concept, lighting management control system.**

**APP remote control**   
**Dimming Range: 5%~100%**



• Versteckte Vorteile/Hidden Advantage

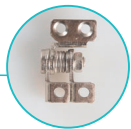

**1 Gelenkverstärkung**  
Kann den Schienenkopf an jeder Stelle halten, ohne sich zu lockern

**Private Joiner**  
Can hold the track head at any point without loosen



**2 360°+Rotation**  
Ohne toten Winkel  
**360°+Rotatable**  
Without dead angle



**3** · Passend für CITIZEN, CREE, LUMINUS COB LED  
· Die Linse passt **ohne Positionierung** vollständig in den LED-Halter  
· PC Material, kann das Licht um 2% erhöhen

· Can fit CITIZEN, CREE, LUMINUS COB LED  
· Lens can fully fit in the LED holder **without positioning**  
· PC material, can increase the lumen 2%

**4 Nur 2 Schritte** sind nötig, um eine neue Linse auszuwechseln, ohne Werkzeug!  
Only 2 Steps to finish replacing a new lens without tools needed!



1. Legen sie die neue Linse bereit  
1. Prepare the new lens



2. Neue Linse **ohne Positionierung** in die LED-Halterung einsetzen  
2. Put the lens in the LED holder **without positioning**



3. Frontring einschrauben  
3. Screw in the front ring

## | Narrow Beam

OMEGA NARROW BEAM ist eine stilvolle und kompakte LED-Spurleuchte, die sich nahtlos in jedes Schaufenster, Museen und in sehr enge Stellen einfügt. Durch einfaches Hinzufügen von zusätzlichem optischem Zubehör kann die Lichtform auf quadratisch, rechteckig, oval, ... geändert werden, was letztendlich eine einzigartige Atmosphäre schafft. Der Kopf kann präzise um 360° horizontal (Drehung) und 90° vertikal ohne toten Winkel verstellt werden. Das Licht, das entsteht, wird genau dort abgegeben, wo Sie es brauchen. Der integrierte Treiber sorgt für ein aufgeräumtes Gefühl und die Decke wird nicht mit Treibern überhäuft, die in verschiedene Richtungen gerichtet sind.

OMEGA NARROW BEAM is a stylish and compact LED track light that will fit smoothly into any show windows, museums where ask for very narrow spot. Simply adding extra optical accessories, the light shape can be changed to square, rectangular, oval, .... creates unique atmosphere in the end. The head can be adjusted precisely 360°+ horizontal (rotation) and 90°vertical without dead angle. The light, as a result, is emitted exactly where you need it. The integrated driver gives clean feeling and the ceiling will not be cluttered with drivers aimed in different directions.





## ZUBEHÖR/EQUIPMENT

Art.-Nr. Item-Nr.	Optisches Zubehör Optical Accessories	Farbe Color
ZB-03013-06	Wand-/Deckenmontage Adapter	schwarz
ZB-03013-07	Wand-/Deckenmontage Adapter	weiß



- Elegantes und kompaktes Design mit integriertem Treiber.
- Sehr enger Abstrahlwinkel 6° mit hochwertiger Lichtverteilung.
- Durch einfaches Hinzufügen von zusätzlichem optischem Zubehör kann die Lichtform auf Quadrat, Rechteck, Linie geändert werden.
- Eine speziell entwickelte Verbindung kann den Schienenkopf an jeder beliebigen Stelle konstant halten.
- 360° + Drehung ohne toten Winkel und 90° vertikale Ausrichtung.
- Nutzen Sie die OMEGA-Familie, um ein einheitliches Konzept zu erhalten.
- Stylish and compact design with integrated driver.
- Very narrow beam 6° with quality light distribution.
- Simply adding extra optical accessories, the light shape can be changed to square, rectangular, line `.
- Privately-designed joints can hold the lights at any positions without malfunctions.
- 360°+ rotation without dead angle and 90°vertical aiming.
- Use OMEGA family to get a unified impression in one environment.

# TRACK LIGHT | OMEGA | NARROW BEAM

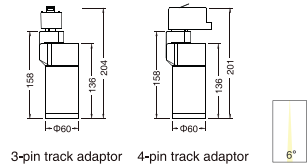
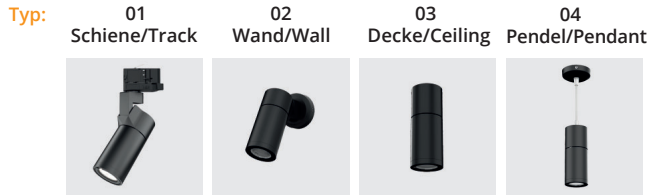

## Oberflächen Farben /Surface Colors:



Für eine dimmbare Version hängen Sie hinter die Art.-N. -D  
For a dimmable version attach behind the item-no. -D

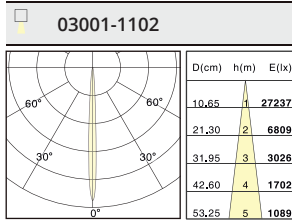

Artikel-Nr. Item-No.	Watt	LED Leistung LED Current	Lumen	CRI	Kelvin	Strahlwinkel Beam Angle
Typ-03001-1102-Farb-Nr.	10 W	700mA	669 lm	90+	3000K	6°
Typ-03001-1103-Farb-Nr.	10 W	700mA	719 lm	90+	4000K	6°

## ZUBEHÖR/EQUIPMENT

Art.-Nr. Item-Nr.	Optisches Zubehör Optical Accessories
ZB-03003	8 Optical Lenses (Set)

### 8 verschiedene Lichtformen

Durch das einfache Hinzufügen eines optischen Zubehörteils, kann die Lichtform sich ändern von einem großen zu einem kleinen Kreis, Quadrat, Rechteck oder einer Linie.

### 8 different Lightshapes

Simply adding extra optical accessories, the light shape can be changed from a small to a big circle, square, rectangular or a line.

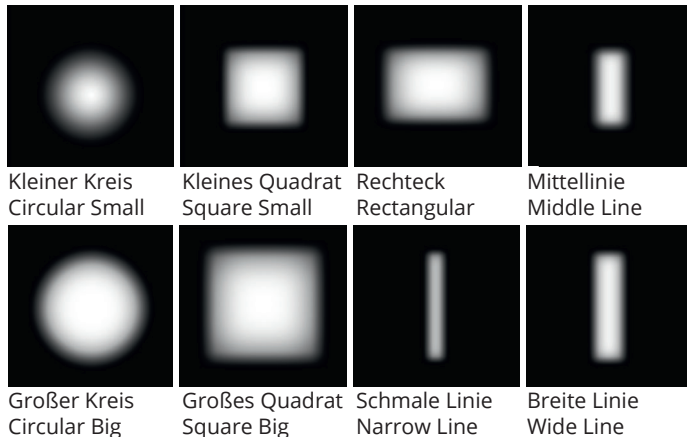

## Ausgezeichnetes modulares Kombinationskonzept Excellent Modular Combination Concept



Schienemontage Basis  
Track-mounted Base



Deckenmontage Basis  
Surface-mounted Base



Pendelmontage Basis  
Pendant-mounted Base



Wandmontage Basis  
Wall-mounted Base

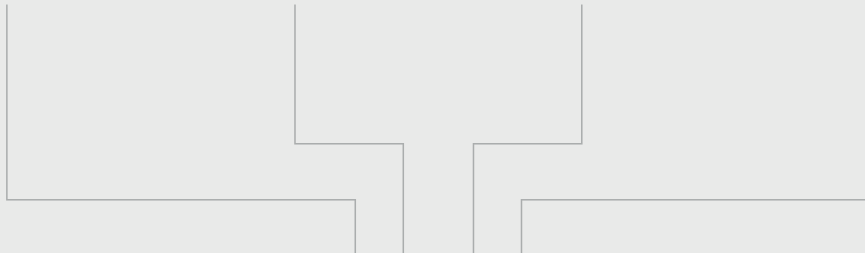

Narrow Beam Lichtmodul  
Narrow Beam Light Engine

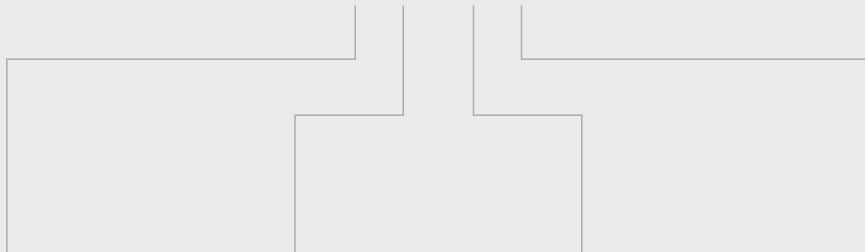

Schienestrahler  
Track-mounted  
01



Deckenstrahler  
Surface-mounted  
03



Pendelstrahler  
Pendant-mounted  
04



Wandstrahler  
Wall-mounted  
02



## Standard

OMEGA STANDARD ist eine stilvolle und kompakte LED-Spurleuchte, die sich nahtlos in jede Einzelhandels- und Galerieumgebung einfügt. Die Frontschürze bietet einen guten Lichtkomfort. Der Kopf kann um 360°+ horizontal (Drehung) und 90° vertikal ohne toten Winkel präzise eingestellt werden. Dadurch wird das Licht genau dort abgegeben, wo Sie es benötigen. Der integrierte Treiber sorgt für ein klares Licht und die Decke wird nicht in verschiedene Richtungen gerichteten Treibern überflutet.

OMEGA STANDARD is a stylish and compact LED track light that will fit smoothly into any retail, gallery environments. The front snoot can bring a good light comfort. The head can be adjusted precisely 360°+ horizontal (rotation) and 90° vertical without dead angle. The light, as a result, is emitted exactly where you need it. The integrated driver gives clean feeling and the ceiling will not be cluttered with drivers aimed in different directions.

### ZUBEHÖR/EQUIPMENT

Art.-Nr. Item-Nr.	Optisches Zubehör Optical Accessories	Farbe Color	
ZB-03013-06	Wand-/Deckenmontage Adapter	schwarz	
ZB-03013-07	Wand-/Deckenmontage Adapter	weiß	





- Elegantes und kompaktes Design mit integriertem Treiber.
- Hervorragendes modulares Kombinationskonzept: integrierter Treiber+ verschiedene Befestigungssockel, DIV für verschiedene Lichtlösungen und einfache Wartung.
- Die Lichtausbeute liegt bei bis zu 95lm/W.
- Wechselobjektiv: 15°,24°,40°,60°.
- Eine speziell entwickelte Verbindung kann den Schienenkopf an jeder beliebigen Stelle störungsfrei halten.
- 360°+ Drehung ohne toten Winkel und 90° vertikale Ausrichtung.
- Mit der OMEGA-Familie erhalten Sie ein einheitliches Konzept.
- Stylish and compact design with integrated driver.
- Excellent modular combination concept: integrated driver+ different fixture bases, DIV to get different light solutions and easy for maintenance.
- Light efficiency is up to 95lm/W.
- Interchangeable lens: 15°, 24°, 40°, 60°.
- Privately-designed joints can hold the lights at any positions without malfunctions.
- 360°+ rotation without dead angle and 90°vertical aiming.
- Use OMEGA family to get a unified impression in one environment.

# TRACK LIGHT | OMEGA | STANDARD

Typ:

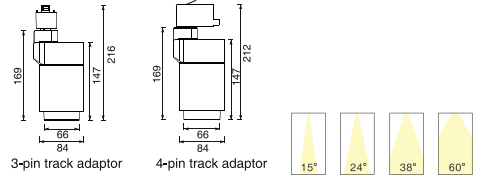

Oberflächen Farben /Surface Colors:



Für eine dimmbare Version hängen Sie hinter die Art.-N. -D  
For a dimmable version attach behind the item-no. -D

Farb-Nr.:

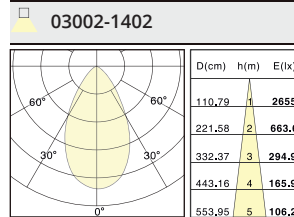
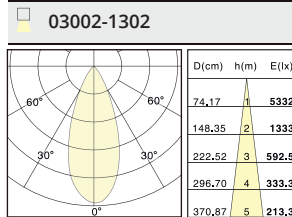
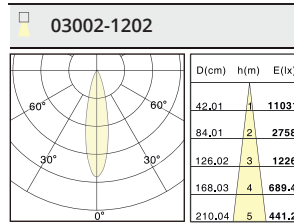
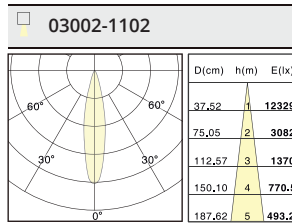

Artikel-Nr. Item-No.	Watt	LED Leistung LED Current	Lumen	CRI	Kelvin	Strahlwinkel Beam Angle
Typ-03002-1102-Farb-Nr.	20 W	520mA	2053 lm	90+	3000K	15°
Typ-03002-1103-Farb-Nr.	20 W	520mA	2208 lm	90+	4000K	15°
Typ-03002-1202-Farb-Nr.	20 W	520mA	2152 lm	90+	3000K	24°
Typ-03002-1203-Farb-Nr.	20 W	520mA	2314 lm	90+	4000K	24°
Typ-03002-1302-Farb-Nr.	20 W	520mA	2134 lm	90+	3000K	38°
Typ-03002-1303-Farb-Nr.	20 W	520mA	2295 lm	90+	4000K	38°
Typ-03002-1402-Farb-Nr.	20 W	520mA	2009 lm	90+	3000K	60°
Typ-03002-1403-Farb-Nr.	20 W	520mA	2160 lm	90+	4000K	60°

Artikel-Nr. Item-No.	Watt	LED Leistung LED Current	Lumen	CRI	Kelvin	Strahlwinkel Beam Angle
Typ-03002-2102-Farb-Nr.	25 W	600mA	2143 lm	90+	3000K	15°
Typ-03002-2103-Farb-Nr.	25 W	600mA	2304 lm	90+	4000K	15°
Typ-03002-2202-Farb-Nr.	25 W	600mA	2250 lm	90+	3000K	24°
Typ-03002-2203-Farb-Nr.	25 W	600mA	2419 lm	90+	4000K	24°
Typ-03002-2302-Farb-Nr.	25 W	600mA	2240 lm	90+	3000K	38°
Typ-03002-2303-Farb-Nr.	25 W	600mA	2408 lm	90+	4000K	38°
Typ-03002-2402-Farb-Nr.	25 W	600mA	2162 lm	90+	3000K	60°
Typ-03002-2403-Farb-Nr.	25 W	600mA	2325 lm	90+	4000K	60°

Artikel-Nr. Item-No.	Watt	LED Leistung LED Current	Lumen	CRI	Kelvin	Strahlwinkel Beam Angle
Typ-03002-3102-Farb-Nr.	30 W	730mA	2696 lm	90+	3000K	15°
Typ-03002-3103-Farb-Nr.	30 W	730mA	2899 lm	90+	4000K	15°
Typ-03002-3202-Farb-Nr.	30 W	730mA	2841 lm	90+	3000K	24°
Typ-03002-3203-Farb-Nr.	30 W	730mA	3055 lm	90+	4000K	24°
Typ-03002-3302-Farb-Nr.	30 W	730mA	2873 lm	90+	3000K	38°
Typ-03002-3303-Farb-Nr.	30 W	730mA	3089 lm	90+	4000K	38°
Typ-03002-3402-Farb-Nr.	30 W	730mA	2741 lm	90+	3000K	60°
Typ-03002-3403-Farb-Nr.	30 W	730mA	2948 lm	90+	4000K	60°

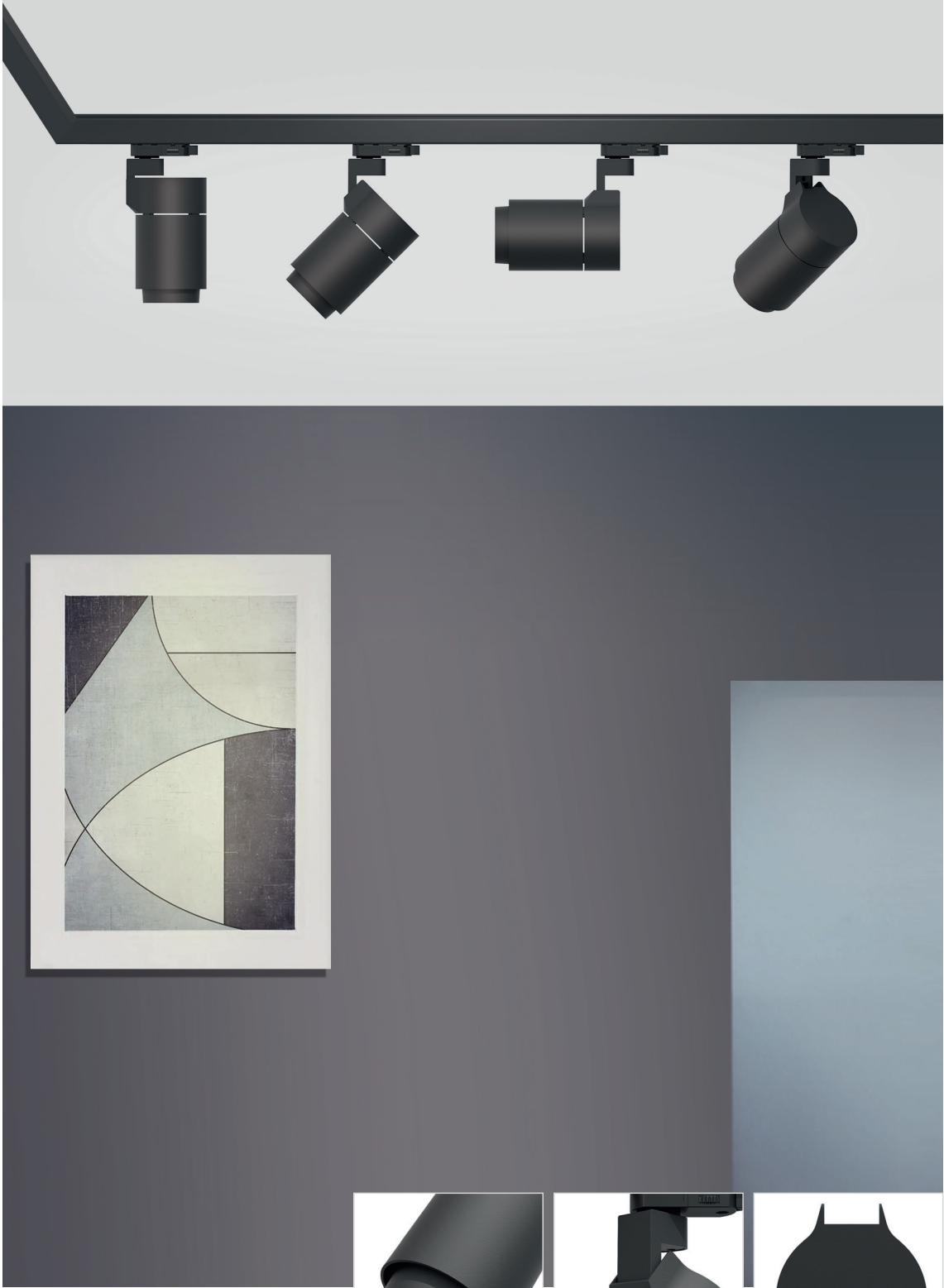

Optisch schönes Design  
Eye comfortable design



Sehr zuverlässiges Gelenk  
Very reliable joint

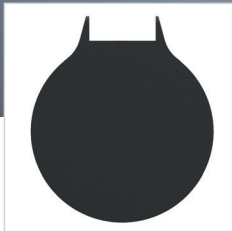

Katzenumriss  
Cat outline

TRACK LIGHT | OMEGA | STANDARD



### Ausgezeichnetes modulares Kombinationskonzept Excellent Modular Combination Concept

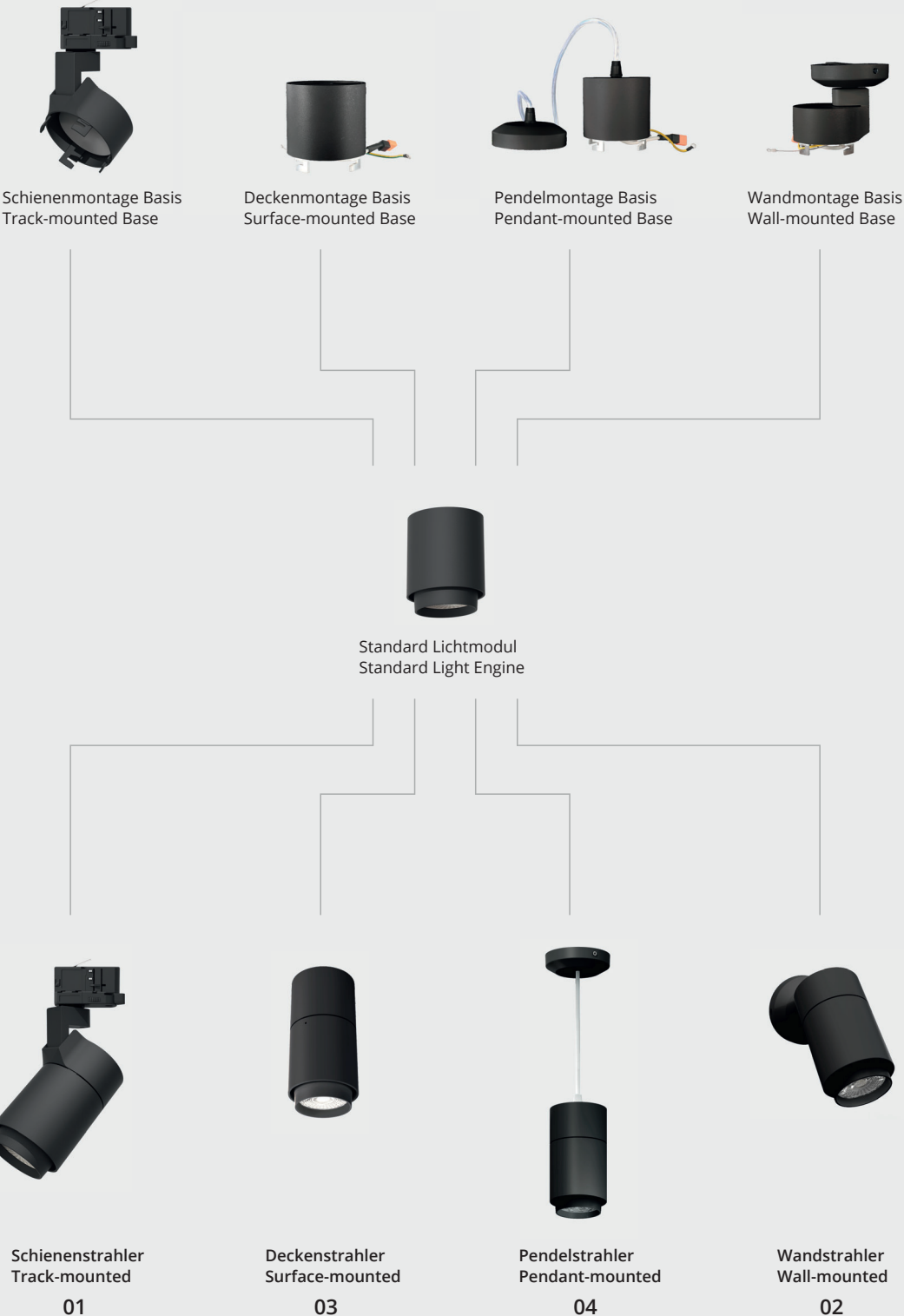



## | Premium

OMEGA PREMIUM ist eine stilvolle und kompakte LED-Schienenleuchte, die sich nahtlos in die Umgebung des Einzelhandels und der Galerien einfügt. Hohe Lichtausbeute (>110lm/W) und vielseitiges optisches Zubehör können den hohen Lichtkomfort erhöhen und unterschiedliche Lichtanforderungen erfüllen. Der Kopf kann exakt um 360°+ horizontal (Drehung) und 90° vertikal ohne toten Winkel verstellt werden. Dadurch haben Sie das Licht genau dort, wo Sie es benötigen. Der integrierte Treiber sorgt für ein klares Licht und die Decke wird nicht mit in verschiedene Richtungen gerichteten Treibern verbaut.

OMEGA PREMIUM is a stylish and compact LED track light that will fit smoothly into any retail, gallery environments. High lumen efficiency (>110lm/W) & versatile optical accessories can increase the great light comfort and fulfill different light demands. The head can be adjusted precisely 360°+ horizontal (rotation) and 90° vertical without dead angle. The light, as a result, is emitted exactly where you need it. The integrated driver gives clean feeling and the ceiling will not be cluttered with drivers aimed in different directions.



## ZUBEHÖR/EQUIPMENT

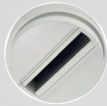

Art.-Nr. Item-Nr.	Optisches Zubehör Optical Accessories	Farbe Color	
ZB-03013-06	Wand-/Deckenmontage Adapter	schwarz	
ZB-03013-07	Wand-/Deckenmontage Adapter	weiß	

### Zubehör Accessories



LUMINUS COB	>110 lm/W	CRI 90+	Dimmable	Max 45°C -20°C	PF >0.90	0°-90°	0°-360°
----------------	--------------	------------	----------	----------------------	-------------	--------	---------

- Elegantes und kompaktes Design mit integriertem Treiber.
- Hervorragendes modulares Kombinationskonzept: integrierter Treiber + verschiedene Befestigungssockel + optisches Zubehör. DIV, um verschiedene Lichtlösungen zu erhalten und einfach zu warten.
- Die Lichtausbeute beträgt bis zu 110lm/W.
- Wechselobjektiv ; 15°, 18°, 24°, 38°,60°.
- Kann mit 6 verschiedenen optischen Zubehörtteilen ausgestattet werden, um die Bildqualität zu verbessern, Blendung zu reduzieren und das Licht abzuschalten.
- Eine speziell entwickelte Verbindung kann den Schienenkopf an jeder beliebigen Stelle konstant halten.
- 360°+ Drehung ohne toten Winkel und 90° vertikale Ausrichtung.
- Mit der OMEGA-Familie erhalten Sie ein einheitliches Konzept.
- Stylish and compact design with integrated driver.
- Excellent modular combination concept: integrated driver + different fixture bases + optical accessories, DIV to get different light solutions and easy for maintenance.
- Light efficiency is up to 110lm/W.
- Interchangeable lens: 15°, 18°, 24°, 38°,60°.
- Can be dressed in 6 kinds of optical accessories to enhance the visual quality, reduce glare and cut off the light.
- Privately-designed joints can hold the track head at any positions without malfunctions.
- 360°+ rotation without dead angle and 90° vertical aiming.
- Use OMEGA family to get a unified impression in one environment.



**Premium small**  
**Premium**  
(10W, 15W)

**Optisches Zubehör**  
**Optical Accessories**



Art.-Nr. Item-Nr.	Optisches Zubehör Optical Accessories	Farbe Color	
ZB-03010-06	Honeycomb Louve	schwarz	
ZB-03011-06	Cross Louve	schwarz	
ZB-03012-06	Barn Door	schwarz	
ZB-03010-07	Honeycomb Louve	weiß	
ZB-03011-07	Cross Louve	weiß	
ZB-03012-07	Barn Door	weiß	



Honeycomb Filter



Cross Louver



Barn Door



Art.-Nr. Item-Nr.	Optisches Zubehör Optical Accessories	Farbe Color	
ZB-03004-06	Honeycomb Louve	schwarz	
ZB-03005-06	Cross Louve	schwarz	
ZB-03006-06	Snoot	schwarz	
ZB-03007-06	Eye Snoot	schwarz	
ZB-03008-06	Wall Wash Ring	schwarz	
ZB-03009-06	Barn Door	schwarz	
ZB-03004-07	Honeycomb Louve	weiß	
ZB-03005-07	Cross Louve	weiß	
ZB-03006-07	Snoot	weiß	
ZB-03007-07	Eye Snoot	weiß	
ZB-03008-07	Wall Wash Ring	weiß	
ZB-03009-07	Barn Door	weiß	

(20W, 25W, 30W)

Optisches Zubehör  
Optical Accessories



Barn Door

Wall Wash Ring

Honeycomb Filter

Eye Snoot

Cross Louver

Snoot

# TRACK LIGHT | OMEGA | PREMIUM SMALL

Typ: 01 Schiene/Track 02 Wand/Wall 03 Decke/Ceiling 04 Pendel/Pendant

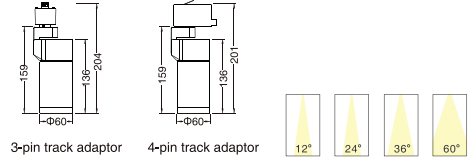

Oberflächen Farben /Surface Colors:



Für eine dimmbare Version hängen Sie hinter die Art.-N. -D  
For a dimmable version attach behind the item-no. -D

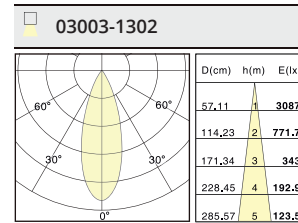
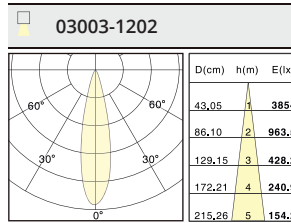
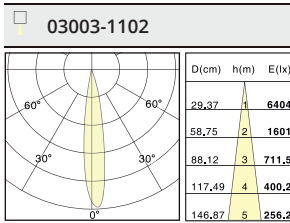

Artikel-Nr. Item-No.	Watt	LED Leistung LED Current	Lumen	CRI	Kelvin	Strahlwinkel Beam Angle
Typ-03003-1102-Farb-Nr.	10 W	250mA	964 lm	90+	3000K	12°
Typ-03003-1103-Farb-Nr.	10 W	250mA	1025 lm	90+	4000K	12°
Typ-03003-1202-Farb-Nr.	10 W	250mA	962 lm	90+	3000K	24°
Typ-03003-1203-Farb-Nr.	10 W	250mA	1023 lm	90+	4000K	24°
Typ-03003-1302-Farb-Nr.	10 W	250mA	1063 lm	90+	3000K	36°
Typ-03003-1303-Farb-Nr.	10 W	250mA	1130 lm	90+	4000K	36°
Typ-03003-1402-Farb-Nr.	10 W	250mA	976 lm	90+	3000K	60°
Typ-03003-1403-Farb-Nr.	10 W	250mA	1038 lm	90+	4000K	60°

Artikel-Nr. Item-No.	Watt	LED Leistung LED Current	Lumen	CRI	Kelvin	Strahlwinkel Beam Angle
Typ-03003-2102-Farb-Nr.	15 W	350mA	1421 lm	90+	3000K	12°
Typ-03003-2103-Farb-Nr.	15 W	350mA	1465 lm	90+	4000K	12°
Typ-03003-2202-Farb-Nr.	15 W	350mA	1385 lm	90+	3000K	24°
Typ-03003-2203-Farb-Nr.	15 W	350mA	1473 lm	90+	4000K	24°
Typ-03003-2302-Farb-Nr.	15 W	350mA	1396 lm	90+	3000K	36°
Typ-03003-2303-Farb-Nr.	15 W	350mA	1486 lm	90+	4000K	36°
Typ-03003-2402-Farb-Nr.	15 W	350mA	1465 lm	90+	3000K	60°
Typ-03003-2403-Farb-Nr.	15 W	350mA	1559 lm	90+	4000K	60°

Typ: 01 Schiene/Track 02 Wand/Wall 03 Decke/Ceiling 04 Pendel/Pendant

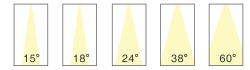
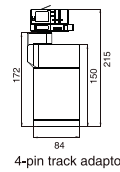
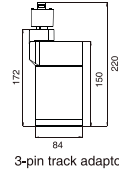

Oberflächen Farben /Surface Colors:



Für eine dimmbare Version hängen Sie hinter die Art.-N. -D  
For a dimmable version attach behind the item-no. -D

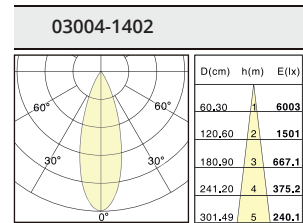
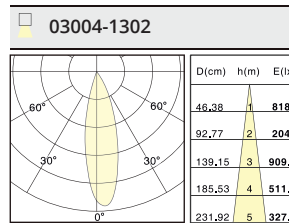
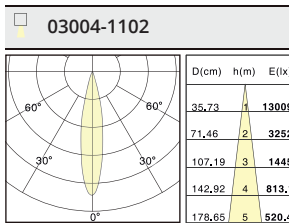

Artikel-Nr. Item-No.	Watt	LED Leistung LED Current	Lumen	CRI	Kelvin	Strahlwinkel Beam Angle
Typ-03004-1102-Farb-Nr.	20 W	520mA	2417 lm	90+	3000K	15°
Typ-03004-1103-Farb-Nr.	20 W	520mA	2517 lm	90+	4000K	15°
Typ-03004-1202-Farb-Nr.	20 W	520mA	2391 lm	90+	3000K	18°
Typ-03004-1203-Farb-Nr.	20 W	520mA	2490 lm	90+	4000K	18°
Typ-03004-1302-Farb-Nr.	20 W	520mA	2371 lm	90+	3000K	24°
Typ-03004-1303-Farb-Nr.	20 W	520mA	2470 lm	90+	4000K	24°
Typ-03004-1402-Farb-Nr.	20 W	520mA	2522 lm	90+	3000K	38°
Typ-03004-1403-Farb-Nr.	20 W	520mA	2627 lm	90+	4000K	38°
Typ-03004-1502-Farb-Nr.	20 W	520mA	2301 lm	90+	3000K	60°
Typ-03004-1503-Farb-Nr.	20 W	520mA	2397 lm	90+	4000K	60°

Artikel-Nr. Item-No.	Watt	LED Leistung LED Current	Lumen	CRI	Kelvin	Strahlwinkel Beam Angle
Typ-03004-2102-Farb-Nr.	25 W	600mA	2747 lm	90+	3000K	15°
Typ-03004-2103-Farb-Nr.	25 W	600mA	2862 lm	90+	4000K	15°
Typ-03004-2202-Farb-Nr.	25 W	600mA	2748 lm	90+	3000K	18°
Typ-03004-2203-Farb-Nr.	25 W	600mA	2862 lm	90+	4000K	18°
Typ-03004-2302-Farb-Nr.	25 W	600mA	2796 lm	90+	3000K	24°
Typ-03004-2303-Farb-Nr.	25 W	600mA	2912 lm	90+	4000K	24°
Typ-03004-2402-Farb-Nr.	25 W	600mA	2884 lm	90+	3000K	38°
Typ-03004-2403-Farb-Nr.	25 W	600mA	3004 lm	90+	4000K	38°
Typ-03004-2502-Farb-Nr.	25 W	600mA	2772 lm	90+	3000K	60°
Typ-03004-2503-Farb-Nr.	25 W	600mA	2887 lm	90+	4000K	60°

Artikel-Nr. Item-No.	Watt	LED Leistung LED Current	Lumen	CRI	Kelvin	Strahlwinkel Beam Angle
Typ-03004-3102-Farb-Nr.	30 W	730mA	3137 lm	90+	3000K	15°
Typ-03004-3103-Farb-Nr.	30 W	730mA	3268 lm	90+	4000K	15°
Typ-03004-3202-Farb-Nr.	30 W	730mA	3118 lm	90+	3000K	18°
Typ-03004-3203-Farb-Nr.	30 W	730mA	3248 lm	90+	4000K	18°
Typ-03004-3302-Farb-Nr.	30 W	730mA	3079 lm	90+	3000K	24°
Typ-03004-3303-Farb-Nr.	30 W	730mA	3208 lm	90+	4000K	24°
Typ-03004-3402-Farb-Nr.	30 W	730mA	3226 lm	90+	3000K	38°
Typ-03004-3403-Farb-Nr.	30 W	730mA	3361 lm	90+	4000K	38°
Typ-03004-3502-Farb-Nr.	30 W	730mA	3246 lm	90+	3000K	60°
Typ-03004-3503-Farb-Nr.	30 W	730mA	3381 lm	90+	4000K	60°



## Ausgezeichnetes modulares Kombinationskonzept Excellent Modular Combination Concept



Schiennenmontage Basis  
Track-mounted Base

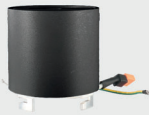

Deckenmontage Basis  
Surface-mounted Base



Pendelmontage Basis  
Pendant-mounted Base



Wandmontage Basis  
Wall-mounted Base



Premium Lichtmodul  
Premium Light Engine



Schienstrahler  
Track-mounted

01



Deckenstrahler  
Surface-mounted

03



Pendelstrahler  
Pendant-mounted

04



Wandstrahler  
Wall-mounted

02



## Zoomable

Art.-Nr. Item-Nr.	Optisches Zubehör Optical Accessories	Farbe Color	
ZB-03013-06	Wand-/Deckenmontage Adapter	schwarz	
ZB-03013-07	Wand-/Deckenmontage Adapter	weiß	

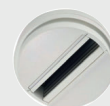

OMEGA ZOOMABLE ist eine stylische und kompakte LED-Schienenleuchte, die sich nahtlos in jede Museums-, Galerie- und Verkaufsumgebung einfügt. Mit einem verstellbaren Strahlmechanismus, der endlose Abstrahlmöglichkeiten von 25° eng bis 60° breit bietet. Der Kopf kann präzise 360° + horizontal (Rotation) und 90° vertikal ohne toten Winkel eingestellt werden. Das Licht wird dadurch genau dort abgegeben, wo Sie es brauchen. Der integrierte Treiber gibt ein klares Gefühl und die Decke wird nicht mit Treibern überhäuft, die in verschiedene Richtungen gerichtet sind.

OMEGA ZOOMABLE is a stylish and compact LED track light that will fit smoothly into any museum, gallery and retail environments. Featuring an adjustable beam mechanism designed to provide endless beam options from a 25° narrow to a 60° wide flood distribution. The head can be adjusted precisely 360°+ horizontal (rotation) and 90° vertical without dead angle. The light, as a result, is emitted exactly where you need it. The integrated driver gives clean feeling and the ceiling will not be cluttered with drivers aimed in different directions.



**Zoomable small**  
(15°-45°)

**Zubehör**  
Accessories

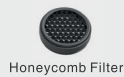

Honeycomb Filter

**Zoomable**  
(25°-60°)



- Elegantes und kompaktes Design mit integriertem Treiber.
- Hervorragendes modulares Kombinationskonzept: integrierter Treiber + verschiedene Befestigungssockel, DIV für unterschiedliche Lichtlösungen und einfache Wartung.
- Der Strahlwinkerverstellmechanismus bietet endlose Strahloptionen aus einer engen bis breiten Flutverteilung durch einfaches Drehen des Gummiringes.
- Die Lichtausbeute beträgt bis zu 90lm/W.
- Eine speziell entwickelte Verbindung kann den Schienenkopf an jeder beliebigen Stelle konstant halten.
- 360°+ Drehung ohne toten Winkel und 90° Ausrichtung.
- Verwenden Sie die OMEGA-Familie, um ein ganzheitliches Konzept zu erhalten.
- Stylish and compact design with integrated driver.
- Excellent modular combination concept: integrated driver+ different fixture bases, DIV to get different lighting solutions and easy for maintenance.
- Beam angle adjustable mechanism provides endless beam options from a narrow to wide flood distribution by simply rotate the rubber ring.
- Light efficiency is up to 90lm/W.
- Privately-designed joints can hold the track head at any positions without malfunctions.
- 360°+ rotation without dead angle and 90° vertical aiming.
- Use OMEGA family to get a unified impression in one environment.

# TRACK LIGHT | OMEGA | ZOOMABLE SMALL

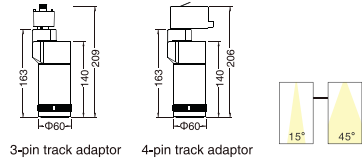

Oberflächen Farben /Surface Colors:



Für eine dimmbare Version hängen Sie hinter die Art.-N. -D  
For a dimmable version attach behind the item-no. -D

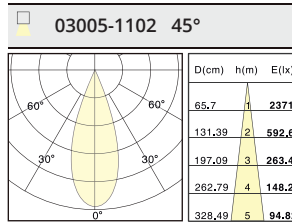
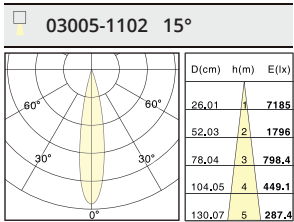

Artikel-Nr. Item-No.	Watt	LED Leistung LED Current	Lumen	CRI	Kelvin	Strahlwinkel Beam Angle
Typ-03005-1102-Farb-Nr.	10 W	250mA	650 - 900lm	90+	3000K	15° - 45°
Typ-03005-1103-Farb-Nr.	10 W	250mA	750 - 1.000lm	90+	4000K	15° - 45°

Artikel-Nr. Item-No.	Watt	LED Leistung LED Current	Lumen	CRI	Kelvin	Strahlwinkel Beam Angle
Typ-03005-2102-Farb-Nr.	15 W	350mA	900 - 1.200lm	90+	3000K	15° - 45°
Typ-03005-2103-Farb-Nr.	15 W	350mA	1.000 - 1.250lm	90+	4000K	15° - 45°



Lichtlösungen/Light solutions  
Beam angle adjustable from 15°-45°

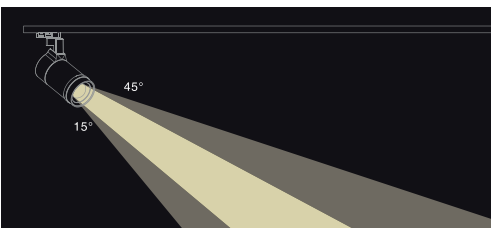

Abstrahlwinkel skalierbar von 15°-45°

## ZUBEHÖR/EQUIPMENT



Art.-Nr. Item-Nr.	Optisches Zubehör Optical Accessories	Farbe Color	
ZB-03001-06	Honeycomb Louve	schwarz	
ZB-03001-07	Honeycomb Louve	weiß	

Typ:

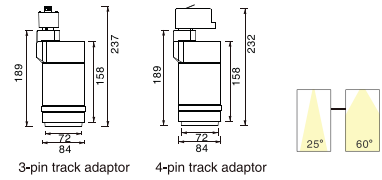

Oberflächen Farben /Surface Colors:



Für eine dimmbare Version hängen Sie hinter die Art.-N. -D  
For a dimmable version attach behind the item-no. -D

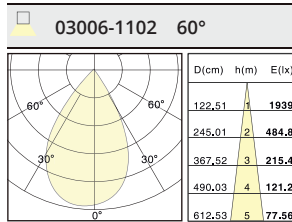
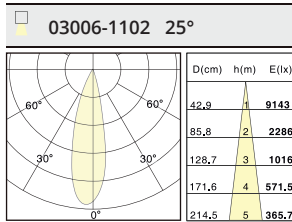

Artikel-Nr. Item-No.	Watt	LED Leistung LED Current	Lumen	CRI	Kelvin	Strahlwinkel Beam Angle
Typ-03006-1102-Farb-Nr.	20 W	520mA	1.900 - 2.100lm	90+	3000K	25° - 60°
Typ-03006-1103-Farb-Nr.	20 W	520mA	2.050 - 2.250lm	90+	4000K	25° - 60°

Artikel-Nr. Item-No.	Watt	LED Leistung LED Current	Lumen	CRI	Kelvin	Strahlwinkel Beam Angle
Typ-03006-2102-Farb-Nr.	25 W	600mA	1.950 - 2.250lm	90+	3000K	25° - 60°
Typ-03006-2103-Farb-Nr.	25 W	600mA	2.100 - 2.400lm	90+	4000K	25° - 60°

Artikel-Nr. Item-No.	Watt	LED Leistung LED Current	Lumen	CRI	Kelvin	Strahlwinkel Beam Angle
Typ-03006-3102-Farb-Nr.	30 W	730mA	2.150 - 2.500lm	90+	3000K	25° - 60°
Typ-03006-3103-Farb-Nr.	30 W	730mA	2.300 - 2.700lm	90+	4000K	25° - 60°



Lichtlösungen/Light solutions  
Beam angle adjustable from 25°-60°

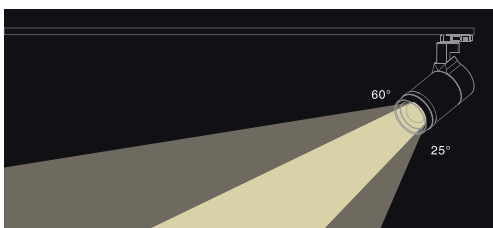

Abstrahlwinkel skalierbar von 25°-60°

ZUBEHÖR/EQUIPMENT



Art.-Nr. Item-Nr.	Optisches Zubehör Optical Accessories	Farbe Color
ZB-03002-06	Honeycomb Louve	schwarz
ZB-03002-07	Honeycomb Louve	weiß



## Ausgezeichnetes modulares Kombinationskonzept Excellent Modular Combination Concept



Schiene**montage** Basis  
Track-mounted Base



Decken**montage** Basis  
Surface-mounted Base



Pendel**montage** Basis  
Pendant-mounted Base



Wand**montage** Basis  
Wall-mounted Base

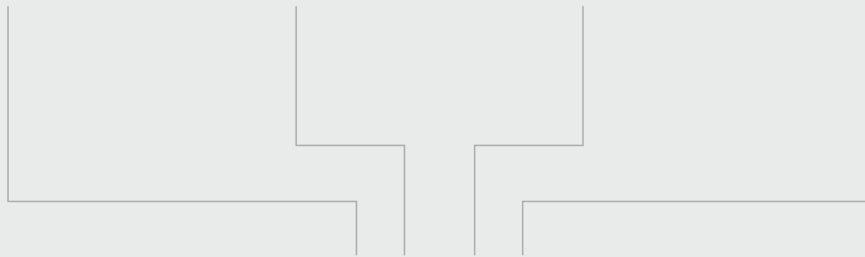

Zoomable Licht**modul**  
Zoomable Light Engine

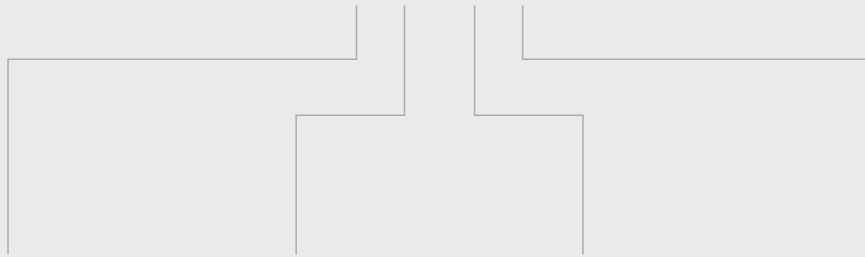

Schiene**strahler**  
Track-mounted

01



Decken**strahler**  
Surface-mounted

02



Pendel**strahler**  
Pendant-mounted

03



Wand**strahler**  
Wall-mounted

04



ZUBEHÖR/EQUIPMENT



Art.-Nr. Item-Nr.	Optisches Zubehör Optical Accessories	Farbe Color	
ZB-03013-06	Wand-/Deckenmontage Adapter	schwarz	
ZB-03013-07	Wand-/Deckenmontage Adapter	weiß	

## Wall Washer

OMEGA WALL WASHER ist eine stilvolle und kompakte LED-Schienenleuchte, die sich problemlos in jede kommerzielle Umgebung einfügt, in der vertikale Beleuchtungsstärken zur Aufhellung und Aufteilung des Raumes erforderlich sind. Sie kann die Wand sehr sanft und gleichmäßig ohne Schatten beleuchten. Der Kopf kann um 360° + horizontal (Rotation) und 90° vertikal ohne toten Winkel präzise eingestellt werden. Dadurch haben Sie das Licht genau dort, wo Sie es brauchen. Der integrierte Treiber sorgt für ein klares Licht und die Decke wird nicht mit Treibern überflutet, die in verschiedene Richtungen gerichtet sind.

OMEGA WALL WASHER is a stylish and compact LED track light that will fit smoothly into any commercial environments where requires vertical illuminance for brightening and dividing the space. It can wash the wall very smoothly and evenly without any shadow. The head can be adjusted precisely 360°+ horizontal (rotation) and 90°vertical without dead angle. The light, as a result, is emitted exactly where you need it. The integrated driver gives clean feeling and the ceiling will not be cluttered with drivers aimed in different directions.



- Elegantes und kompaktes Design mit integriertem Treiber.
- Hervorragendes modulares Kombinationskonzept, integrierter Treiber + verschiedene Befestigungssockel, DIV für verschiedene Lichtlösungen und einfache Wartung.
- Asymmetrische Lichtverteilung für eine sehr gleichmäßige Wandausleuchtung 25\* 75°.
- Eine speziell entwickelte Verbindung kann den Schienenkopf an jeder beliebigen Stelle konstant halten.
- 360°+ Drehung ohne toten Winkel und 90° vertikale Ausrichtung.
- Nutzen Sie die OMEGA-Familie, um einen einheitlichen Eindruck zu erhalten.
- Stylish and compact design with integrated driver.
- Excellent modular combination concept: integrated driver + different fixture bases, DIV to get different light solutions and easy for maintenance.
- Asymmetrical light distribution for highly uniform wallwashing, 25\*75°.
- Privately-designed joints can hold the track head at any positions without malfunctions.
- 360°+ rotation without dead angle and 90°vertical aiming.
- Use OMEGA family to get a unified impression in one environment.

# TRACK LIGHT | OMEGA | WALL WASHER

Typ:

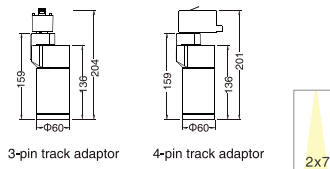
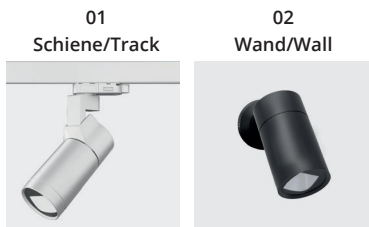

Oberflächen Farben /Surface Colors:



Für eine dimmbare Version hängen Sie hinter die Art.-N. -D  
For a dimmable version attach behind the item-no. -D

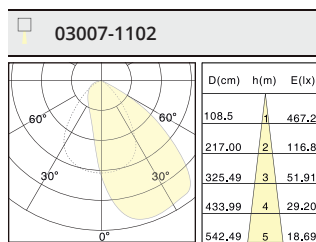

Artikel-Nr. Item-No.	Watt	LED Leistung LED Current	Lumen	CRI	Kelvin	Strahlwinkel Beam Angle
Typ-03007-1102-Farb.-Nr.	10 W	250mA	730lm	90+	3000K	25°75°
Typ-03007-1103-Farb.-Nr.	10 W	250mA	785lm	90+	4000K	25°75°
Typ-03007-1104-Farb.-Nr.	10 W	250mA	844lm	90+	5000K	25°75°

Typ:

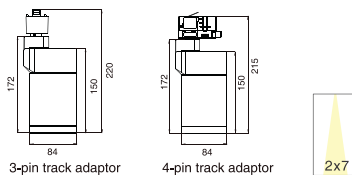

Oberflächen Farben /Surface Colors:



Für eine dimmbare Version hängen Sie hinter die Art.-N. -D  
For a dimmable version attach behind the item-no. -D

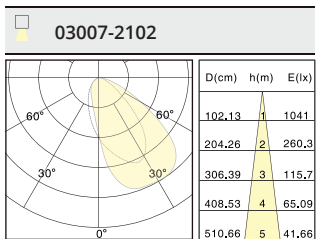

Artikel-Nr. Item-No.	Watt	LED Leistung LED Current	Lumen	CRI	Kelvin	Strahlwinkel Beam Angle
Typ-03007-2102-Farb.-Nr.	20 W	500mA	1675lm	90+	3000K	25°75°
Typ-03007-2103-Farb.-Nr.	20 W	500mA	1801lm	90+	4000K	25°75°
Typ-03007-2104-Farb.-Nr.	20 W	500mA	1936lm	90+	5000K	25°75°

## Ausgezeichnetes modulares Kombinationskonzept Excellent Modular Combination Concept



Schienenmontage Basis  
Track-mounted Base



Wandmontage Basis  
Wall-mounted Base

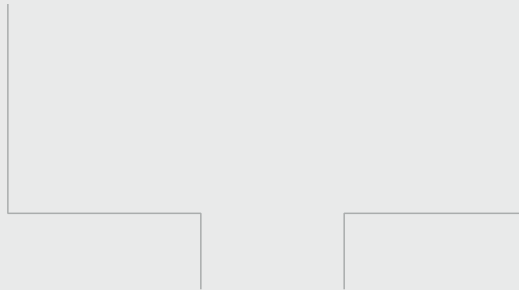

Wall Washer Lichtmodul  
Wall Washer Light Engine

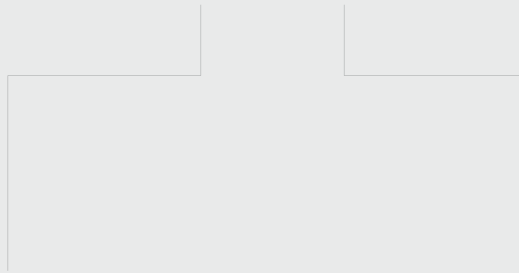

Schienenstrahler  
Track-mounted

01



Wandstrahler  
Wall-mounted

02



## ZUBEHÖR/EQUIPMENT



Art.-Nr. Item-Nr.	Optisches Zubehör Optical Accessories	Farbe Color	
ZB-03013-06	Wand-/Deckenmontage Adapter	schwarz	
ZB-03013-07	Wand-/Deckenmontage Adapter	weiß	

## Plus

OMEGA PLUS ist eine weiterentwickelte Version von OMEGA, mit Ausnahme seines sehr stilvollen und attraktiven Designs. PLUS kombiniert auch Strahler, Flutlicht und Wandflutung in einer Einzeleuchte, so dass sie sich nahtlos in jede Innenumgebung einfügt, in der unterschiedliche Lichtlösungen benötigt werden, aber einen einheitlichen Eindruck hinterlassen werden soll. Der Kopf kann exakt um 360°+ horizontal (Drehung) und 90° vertikal ohne toten Winkel verstellt werden. Dadurch wird das Licht genau dort abgegeben, wo Sie es benötigen. Der integrierte Treiber sorgt für ein sauberes Licht und die Decke wird nicht mit in verschiedene Richtungen gerichteten Treibern überflutet.

OMEGA PLUS is a upgraded version, except for it's very stylish and attractive design, PLUS also combines spotlights, floodlight and wallwashing in a single luminaire, so it will fit smoothly into any indoor environments where requires different lighting solutions, but want to get a unified impression. The head can be adjusted precisely 360°+ horizontal (rotation) and 90°vertical without dead angle. The light, as a result, is emitted exactly where you need it. The integrated driver gives clean feeling and the ceiling will not be cluttered with drivers aimed in different directions.

## Omega Plus

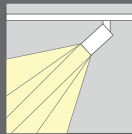

**Spot Strahler**  
Sehr enger bis weiter Strahl, rotierende symmetrische Lichtverteilung für akzentuiertes Licht

30W-40W  
Lichtverteilung: punktuell, Spot- und Flutlicht

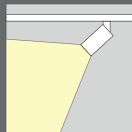

**Flutlicht**  
Sehr weite rotierende symmetrische Lichtverteilung für Flutlicht

30W-40W  
Lichtverteilung: weites, lineares und extra-weites Flutlicht

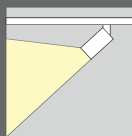

**Wandflutlicht**  
Asymmetrische Lichtverteilung für einheitliches Wandflutlicht

30W-40W  
Lichtverteilung: Wandflutlicht

**Wallwashing**  
Asymmetrical light distribution for uniform wall washing

30W-40W  
Light distribution: Wallwash



- Stilvolles und attraktives Design dank der schönen Kombination von rund und quadratisch.
- Hervorragendes modulares Kombinationskonzept: integrierter Treiber + verschiedene Befestigungssockel, DIY für verschiedene Lichtlösungen und einfache Wartung.
- Kombiniert Strahler, Scheinwerfer und Wandfluter in einer Leuchte.
- Eine speziell entwickelte Verbindung kann den Schienenkopf an jeder beliebigen Stelle störungsfrei halten.
- 360° + Drehung ohne toten Winkel und 90° vertikales Zielen.
- Nutzen Sie die OMEGA-Familie, um einen einheitlichen Eindruck zu erhalten.
- Stylish and attractiv design thanks to the beautiful combination of round and square.
- Excellent modular combination concept: integrated driver + different fixture bases, DIY to get different light solutions and easy for maintenance.
- Combines spotlights, floodlight and wall-washing in a single luminaire.
- Privately-designed joints can hold the track head at any positions without malfunctions.
- 360°+ rotation without dead angle and 90°vertical aiming.
- Use OMEGA family to get a unified impression in one environment.

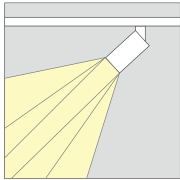

punktuell  
Spot Light

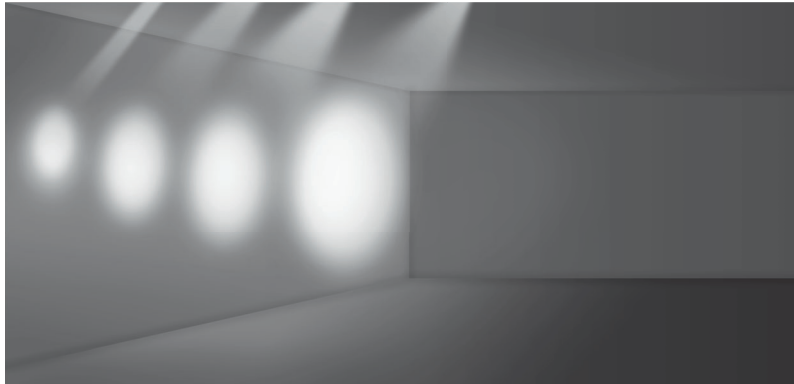

Typ:

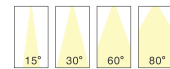
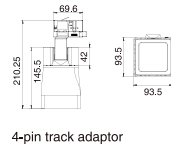
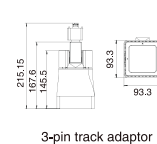

Oberflächen Farben /Surface Colors:



Farb-Nr.:

03  
Silber

06  
Schwarz

07  
Weiß

Für eine dimmbare Version hängen Sie hinter die Art.-N. -D  
For a dimmable version attach behind the item-no. -D

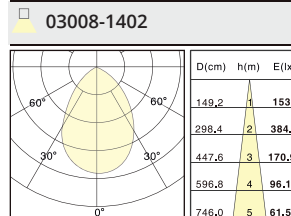
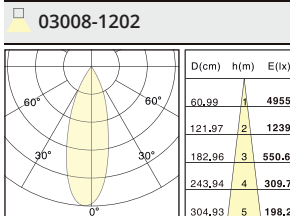
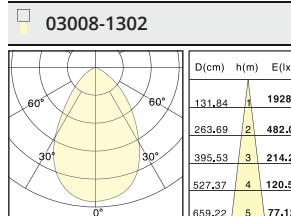
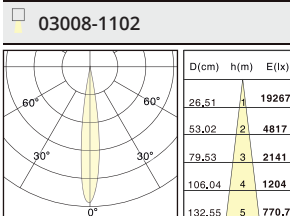

Artikel-Nr. Item-No.	Watt	LED Leistung LED Current	Lumen	CRI	Kelvin	Strahlwinkel Beam Angle
Typ-03008-1102-Farb.-Nr.	35W	1100mA	2728 lm	90+	3000K	15°
Typ-03008-1103-Farb.-Nr.	35W	1100mA	2872 lm	90+	4000K	15°
Typ-03008-1202-Farb.-Nr.	35W	1100mA	2513 lm	90+	3000K	30°
Typ-03008-1203-Farb.-Nr.	35W	1100mA	2645 lm	90+	4000K	30°
Typ-03008-1302-Farb.-Nr.	35W	1100mA	2567 lm	90+	3000K	60°
Typ-03008-1303-Farb.-Nr.	35W	1100mA	2703 lm	90+	4000K	60°
Typ-03008-1402-Farb.-Nr.	35W	1100mA	2380 lm	90+	3000K	80°
Typ-03008-1403-Farb.-Nr.	35W	1100mA	2505 lm	90+	4000K	80°

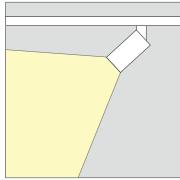

Flutlicht  
Floodlight

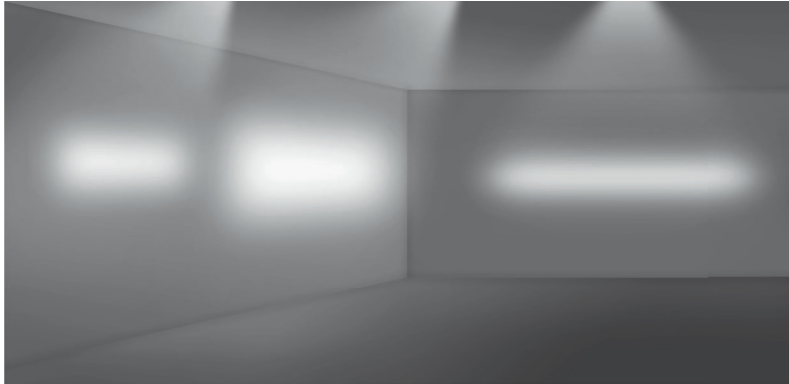

Typ:

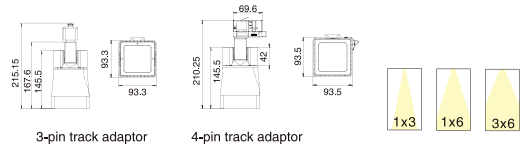
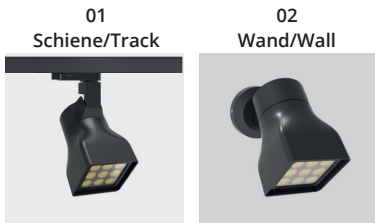

Oberflächen Farben /Surface Colors:



Für eine dimmbare Version hängen Sie hinter die Art.-N. -D  
For a dimmable version attach behind the item-no. -D

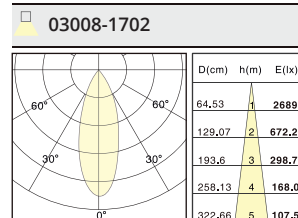
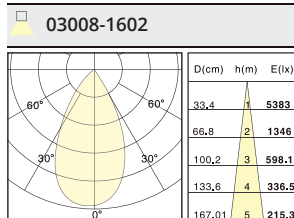
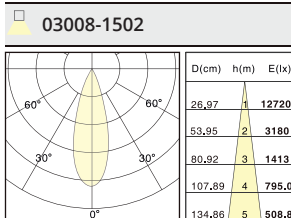

Artikel-Nr. Item-No.	Watt	LED Leistung LED Current	Lumen	CRI	Kelvin	Strahlwinkel Beam Angle
Typ-03008-1502-Farb.-Nr.	35W	1100mA	2716 lm	90+	3000K	15x30°
Typ-03008-1503-Farb.-Nr.	35W	1100mA	2859 lm	90+	4000K	15x30°
Typ-03008-1602-Farb.-Nr.	35W	1100mA	2522 lm	90+	3000K	10x60°
Typ-03008-1603-Farb.-Nr.	35W	1100mA	2654 lm	90+	4000K	10x60°
Typ-03008-1702-Farb.-Nr.	35W	1100mA	2106 lm	90+	3000K	30x60°
Typ-03008-1703-Farb.-Nr.	35W	1100mA	2217 lm	90+	4000K	30x60°

# TRACK LIGHT | OMEGA | PLUS

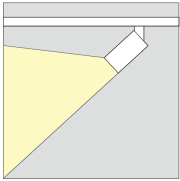

Wandflutlicht  
Wallwashing



Typ:

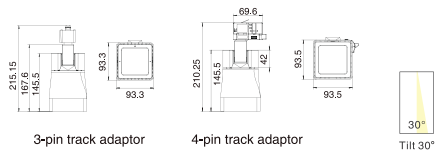
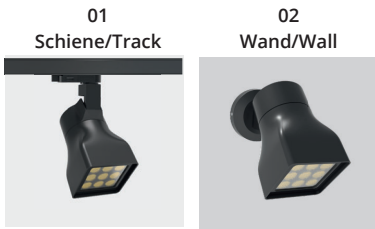

Oberflächen Farben /Surface Colors:



Für eine dimmbare Version hängen Sie hinter die Art.-N. -D  
For a dimmable version attach behind the item-no. -D

03008-1802

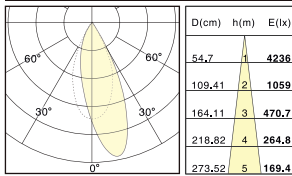

Artikel-Nr. Item-No.	Watt	LED Leistung LED Current	Lumen	CRI	Kelvin	Strahlwinkel Beam Angle
Typ-03008-1802-Farb.-Nr.	35 W	1100mA	2660 lm	90+	3000K	30°
Typ-03008-1803-Farb.-Nr.	35 W	1100mA	2800 lm	90+	4000K	30°



## Ausgezeichnetes modulares Kombinationskonzept Excellent Modular Combination Concept



Schienenmontage Basis  
Track-mounted Base



Wandmontage Basis  
Wall-mounted Base

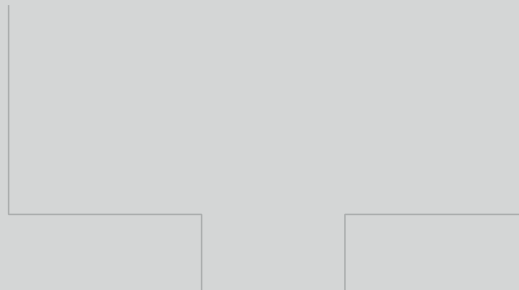

Plus Lichtmodul  
Plus Light Engine

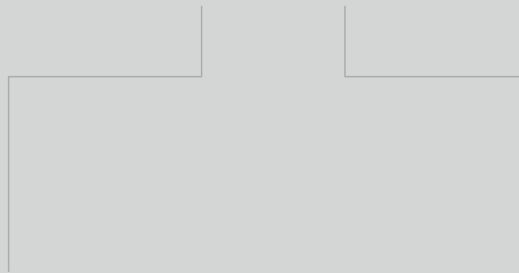

Schienenstrahler  
Track-mounted

01



Wandstrahler  
Wall-mounted

02

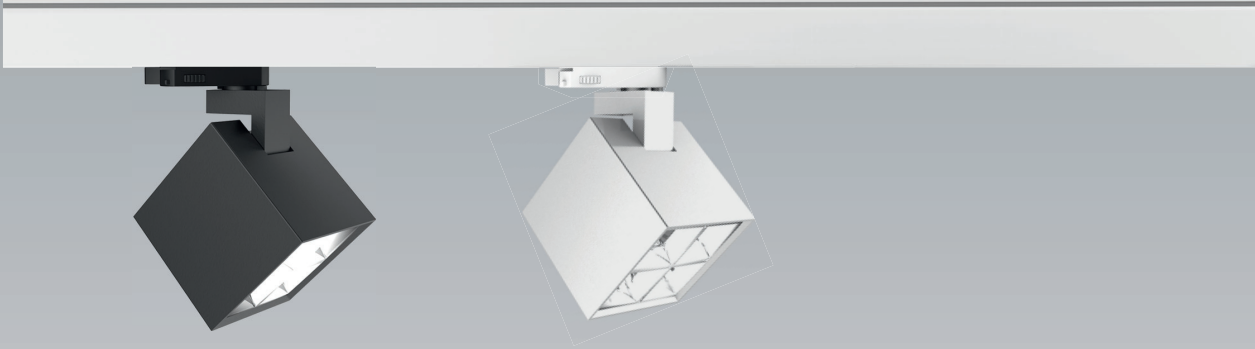

## Kingo

Die OMEGA Kingo Familie ist eine stilvolle und kubische LED-Schienenleuchte, die Einzelhandels-, Galerie- und Museums-umgebungen zu etwas ganz Besonderem macht. Es umfasst eine leistungsstarke Akzentbeleuchtung mit verschiedenen Strahlern, Flutlichtern und Wandflutern. Die KINGO-S-Version kann Schienen-, Aufputz-, Aufbau- und Pendelmontage unterstützen, wenn Sie eine Umgebung haben, die nach verschiedenen Installationsmethoden und Beleuchtungslösungen verlangt. KINGO ist eine sehr gute Wahl, um einen einheitlichen Eindruck zu vermitteln.

OMEGA KINGO family is a stylish and cubic LED track light that make the retail, gallery and museum environments looks very special. It covers high performance accent lighting with various spotlights, floodlighting and wall washing. KINGO-S version can support track-mounted, surface-mounted and suspending, so if you have an environment asking for different installation methods and different lighting solutions, KINGO will be a very good choice to get a unified impression.



## ZUBEHÖR/EQUIPMENT

Art.-Nr. Item-Nr.	Optisches Zubehör Optical Accessories	Farbe Color	
ZB-03013-06	Wand-/Deckenmontage Adapter	schwarz	
ZB-03013-07	Wand-/Deckenmontage Adapter	weiß	



## ÜBERSICHT

<b>Anwendung:</b>	Schiene, Decke, Pendel
<b>Lichtquelle:</b>	Hochvolt LED
<b>Lichtaustritt:</b>	Spot Strahler 15°, 20°, 30°, 45°, 60° Flutlicht 40°x20°, 60°x10°, 50°x50°, 80°x80°
<b>Abstrahlwinkel:</b>	<3
<b>Watt:</b>	18W-30W
<b>Farbtemperatur:</b>	3000K, 4000K
<b>Lumen:</b>	1713lm-2875lm
<b>Schaltoptionen:</b>	an/aus, dimmbar
<b>CRI:</b>	90+
<b>Gehäusefarbe:</b>	Weiß, Schwarz, Silber

## OVERVIEW

<b>Application:</b>	Track-mounted, Pendant, Surface-mounted
<b>Light source:</b>	High power LED
<b>Light solution:</b>	Spotlights 15°, 20°, 30°, 45°, 60° Floodlights 40°x 20°, 60°x10°, 50°x50°, 80°x80°
<b>SDCM:</b>	<3
<b>Watt:</b>	18W-30W
<b>CCT:</b>	3000K, 4000K
<b>Luminous:</b>	1713lm-2875lm
<b>Control option:</b>	On/off, Triac
<b>CRI:</b>	90+
<b>Color:</b>	White, Black, Silver



## Kingo-S

OMEGA Kingo S ist eine stilvolle und kubische LED-Schienenleuchte, die die Einzelhandels-, Galerie- und Museumsumgebungen zu etwas ganz Besonderem macht. Die Optik ist für eine breite Flutlichtbeleuchtung bis zur maximalen Fläche ausgelegt. Der Kopf kann um 360° + horizontal (Rotation) ohne toten Winkel und 90° vertikal präzise eingestellt werden. Dadurch haben Sie das Licht genau dort, wo Sie es brauchen. Der integrierte Treiber sorgt für ein klares Licht und die Decke wird nicht mit in verschiedene Richtungen gerichteten Treibern überflutet.

OMEGA KINGO-S is a stylish and cubic LED track light that make the retail, gallery and museum environments looks very special. Optics designed for wide flood lighting, to light maximum area. The head can be adjusted precisely 360°+ horizontal(rotation) without dead angle and 90°vertical. The light, as a result, is emitted exactly where you need it. The integrated driver gives clean feeling and the ceiling will not be cluttered with drivers aimed in different directions.



- Der kleine stylische Cubus verleiht der Anwendung mehr Kreativität.
- Für eine breite Flutlicht-Optik stehen 50° x 50° und 80° x 80° zur Auswahl.
- Eine speziell entwickelte Verbindung kann den Schienenkopf an jeder beliebigen Stelle störungsfrei halten.
- 360° + Drehung ohne toten Winkel und 90° vertikale Ausrichtung.
- Geeignet für Schienen-, Decken- und Pendelmontage
- Stylish small cubic design gives the application more creativity.
- Optics designed for wide flood lighting, 50°x 50° and 80°x 80° for choice.
- Privately-designed joint can hold the track head at any positions without malfunctions.
- 360°+ rotation without dead angle and 90°vertical aiming.
- Support track-, surface- and pendant-mounting.



ZUBEHÖR/EQUIPMENT

Art.-Nr. Item-Nr.	Optisches Zubehör Optical Accessories	Farbe Color
ZB-03013-06	Wand-/Deckenmontage Adapter	schwarz
ZB-03013-07	Wand-/Deckenmontage Adapter	weiß



Typ:

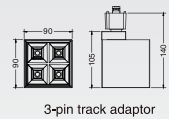
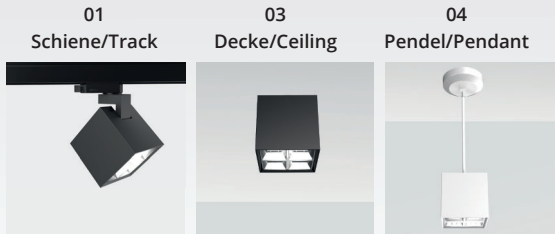

3-pin track adaptor

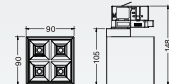

4-pin track adaptor



Oberflächen Farben /Surface Colors:



Für eine dimmbare Version hängen Sie hinter die Art.-N. -D  
For a dimmable version attach behind the item-no. -D

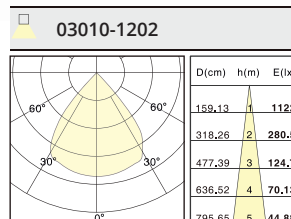
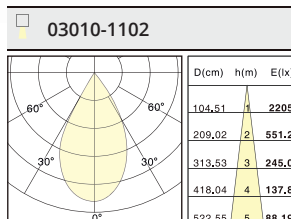

Artikel-Nr. Item-No.	Watt	LED Leistung LED Current	Lumen	CRI	Kelvin	Strahlwinkel Beam Angle
Typ-03010-1102-Farb.-Nr.	18 W	500mA	1659 lm	90+	3000K	50°X50°
Typ-03010-1103-Farb.-Nr.	18 W	500mA	1784 lm	90+	4000K	50°X50°
Typ-03010-1202-Farb.-Nr.	18 W	500mA	1651 lm	90+	3000K	80°x80°
Typ-03010-1203-Farb.-Nr.	18 W	500mA	1776 lm	90+	4000K	80°x80°



## Kingo

OMEGA Kingo ist eine stilvolle und zweifach kubische LED-Schienenleuchte, die die Einzelhandels-, Galerie- und Museumsumgebungen ganz besonders aussehen lässt. Optiken, die für enge, mittlere und breite Ausstrahlwinkel ausgelegt sind, können auch als Wandfluter verwendet werden, um unterschiedliche Lichtenforderungen zu erfüllen. Der Treiber ist in das Gesamtkonzept integriert und trennt sich von der LED für ein optimales Wärmemanagement. Der Kopf kann präzise 360° + horizontal (Rotation) ohne toten Winkel und 90° vertikal eingestellt werden. Dadurch haben Sie das Licht genau dort, wo Sie es brauchen.

OMEGA KINGO is a stylish and dual-cubic LED track light that make the retail, gallery and museum environments looks very special. Optics designed for narrow, medium and wide beams, also can be wall washer, to fulfill different light demands. The driver compartment is integrated in the overall design and maintains a separation from LED for optimal thermal management. The head can be adjusted precisely 360°+ horizontal(rotation) without dead angle and 90°vertical. The light, as a result, is emitted exactly where you need it.

OSRAM COB	>85 lm/W	CRI 90+	Dimmable	Dimmable 1-10V	Max 45°C -20°C	PF >0.90	0°-90°	0°-360°
--------------	-------------	------------	----------	-------------------	----------------------	-------------	--------	---------

- Die Überlappung von zwei schlanken Würfeln verleiht der Leuchte mehr Flexibilität und Kreativität.
- Designed für enge, mittlere oder breite Abstrahlwinkel, auch als Wandfluter geeignet.
- Unterstützt Triac, 1-10V und Dali Dimmer durch genügend Platz in der kubischen Treiberbox.
- Eine speziell entwickelte Verbindung kann den Schienenkopf an jeder beliebigen Stelle konstant halten.
- 360°+ Drehung ohne toten Winkel und 90° vertikale Ausrichtung.
- Overlapping of two slim cubes give the luminaire more flexibility and creativity.
- Optics designed for narrow, medium and wide beams, also can be wall washer.
- Support Triac, 1-10V and DALI dimming thanks to enough drive-box space in a cubic design.
- Privately-designed joint can hold the track head at any positions without malfunctions.
- 360°+ rotation without dead angle and 90°vertical aiming.

Typ:

01

Schiene/Track

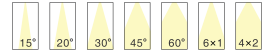
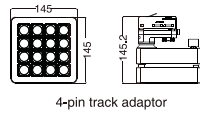
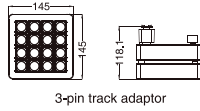

Oberflächen Farben / Surface Colors:



Für eine dimmbare Version hängen Sie hinter die Art.-N. -D  
For a dimmable version attach behind the item-no. -D

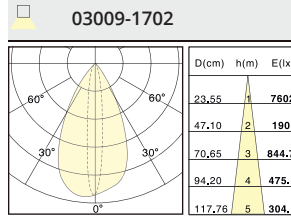
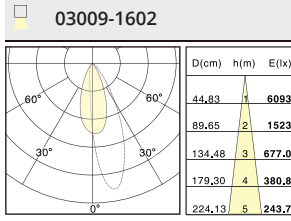
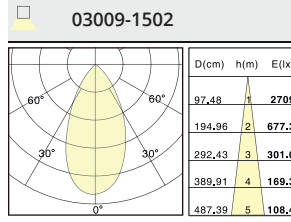
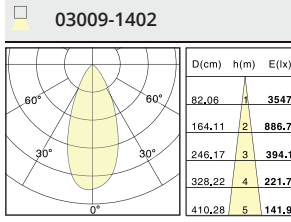
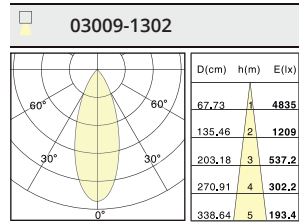
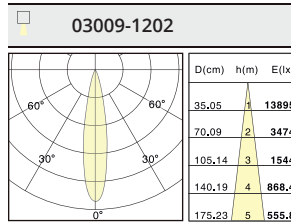
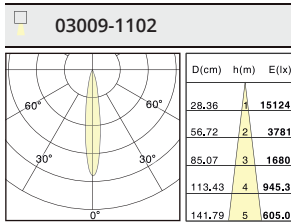

Artikel-Nr. Item-No.	Watt	LED Leistung LED Current	Lumen	CRI	Kelvin	Strahlwinkel Beam Angle
Typ-03009-1102-Farb.-Nr.	30 W	550mA	2490 lm	90+	3000K	15°
Typ-03009-1103-Farb.-Nr.	30 W	550mA	2673 lm	90+	4000K	15°
Typ-03009-1202-Farb.-Nr.	30 W	550mA	2571 lm	90+	3000K	20°
Typ-03009-1203-Farb.-Nr.	30 W	550mA	2760 lm	90+	4000K	20°
Typ-03009-1302-Farb.-Nr.	30 W	550mA	2364 lm	90+	3000K	30°
Typ-03009-1303-Farb.-Nr.	30 W	550mA	2510lm	90+	4000K	30°
Typ-03009-1402-Farb.-Nr.	30 W	550mA	2448 lm	90+	3000K	45°
Typ-03009-1403-Farb.-Nr.	30 W	550mA	2612 lm	90+	4000K	45°
Typ-03009-1502-Farb.-Nr.	30 W	550mA	2360 lm	90+	3000K	60°
Typ-03009-1503-Farb.-Nr.	30 W	550mA	2530 lm	90+	4000K	60°
Typ-03009-1602-Farb.-Nr.	30 W	550mA	2340 lm	90+	3000K	20x40°
Typ-03009-1603-Farb.-Nr.	30 W	550mA	2510 lm	90+	4000K	20x40°
Typ-03009-1702-Farb.-Nr.	30 W	550mA	2329 lm	90+	3000K	10x60°
Typ-03009-1703-Farb.-Nr.	30 W	550mA	2500 lm	90+	4000K	10x60°

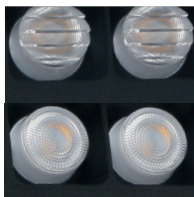

Unterschiedliche Linsen  
Different lenses



Optimiertes Kühlsystem  
Optimized cooling system

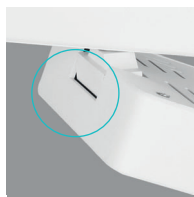

Halt an jeder Position  
Hold at any point



Eingebauter Dimmer (nur 1-10V)  
Built-in dimmer (only 1-10V)

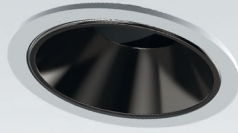
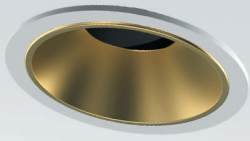

## LUXX

Luxx ist nicht nur ein ästhetisch gestaltetes Downlight, sondern durch die Kombination von Präzisions-Lichtreflektor und Sekundärreflektor auch qualitativ hochwertiges Licht. Vier Baugrößen mit Leistungen von 5 W bis 25 W sowie verstellbarer und fester Ausführung, LUXX ist wirklich ein LED-Downlightsystem. Wenn Sie also eine Umgebung haben, in der Sie nach einer anderen Lichtlösung und verschiedenen Ausschnitten suchen, ist die Luxx-Familie eine gute Wahl, um einen einheitlichen Eindruck zu erhalten.

LUXX is not only an aesthetic designed downlight, but also release high quality light thanks to combination of a precision light beam reflector and secondary reflector. Four sizes with wattages from 5W to 25W plus adjustable version and fixed version, LUXX is truly a LED down light system. So, when you have an environment where ask for different light solution & different cut-outs, LUXX family will be a great choice to get a unified impression.



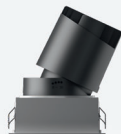
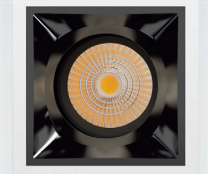
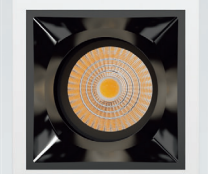
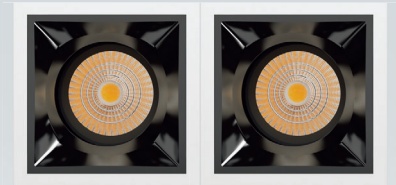
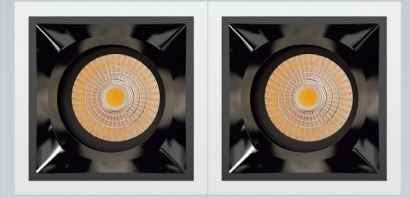
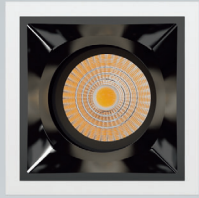

LED DOWNLIGHT SYSTEM **Luxx Übersicht/Overview**

<p><b>Serie</b> Series</p>	Adjustable										
<p><b>Bilder</b> Pictures</p>	 Round Adjustable				 Square Adjustable						
<p><b>Seite/Page</b>  <b>Modell &amp; Größe</b> Model &amp; Size  <b>mm</b></p>	71  47,8 Φ 50	71  85,7 Φ 75	72  105 Φ 95	72  132 Φ 120	74-81  89 Φ 82						
<p><b>Trimless Version</b></p>	 				 						
<p><b>Watt</b> Lumen</p>	5W 252lm	10W 565lm	18W 1069lm	25W 1592lm	10W 565lm						
<p><b>Abstrahlwinkel (°)</b> Beam Angle (°)</p>	10W: 15°, 24°, 38° 18W: 15°, 24°, 38°, 60°		15W: 15°, 24°, 38° 25W: 15°, 24°, 38°		15°, 24°, 38°						
<p><b>Farbtemperatur</b> Color Temperature</p>	2.700K 3.000K				2.700K 3.000K						
<p><b>CRI</b></p>	90+				90+						
<p><b>Dimmen</b> Dimming</p>	optional dimmbar optionally dimmable				optional dimmbar optionally dimmable						
<p><b>Secondary Reflector</b> Farbe Color</p>	 Schwarz Black  Weiß White  Gold Gold  Silber Silver  Champagner Champagne										
<p><b>Blendschutzzubehör</b> Anti-glare Accessories</p>	5W  Wabenmuster Honeycomb	10W  Wabenmuster Honeycomb	10W  Halbsoftes Licht Medium Soft Light				18W  Rechteckiges Licht Rectangular Light		25W  Quadratisches Licht Square Light		 Softes Flutlicht Flood Soft Light



## Lichtqualität/Light Quality

### • Licht

Licht ist ein Erlebnis und kreiert eine einzigartige Atmosphäre. Dank der Kombination verschiedener Reflektoren schaffen die LUXX Strahler qualitativ hochwertiges Licht. Die Lichtrichtung kann um 30° geneigt werden, um an der Wand oder auf den Boden eine gleichmäßige Lichtverteilung zu projizieren.

### Light

Light is an experience. Light creates unique atmospheres. Thanks to combination of a precisim light beam reflector and secondary reflector, LUXX releases a high quality light in the end. The light direction can be tilt 30° to wash the wall or faceto the floor with clean and smooth light distribution.

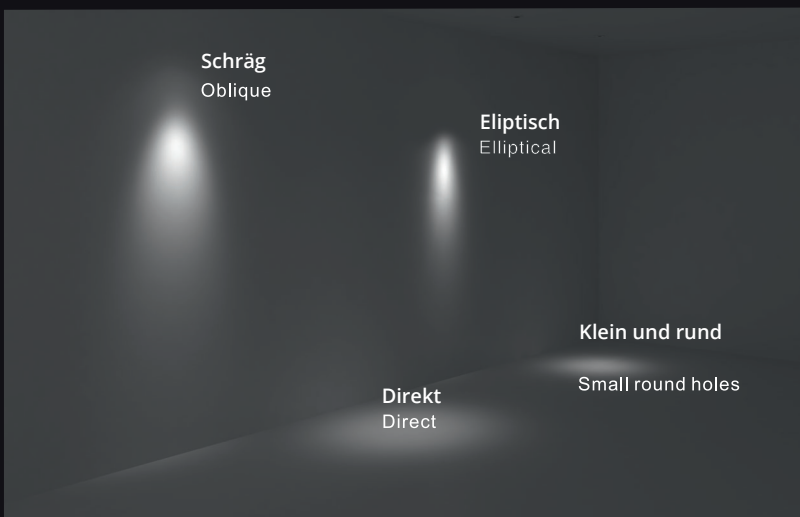

### • Präzise Steuerung des Lichts

Vier Arten von Leuchtringen, die ausgewählt werden können, um eine unterschiedliche Lichtpunktatmosphäre und eine hervorragende Lichtform zu erzeugen. Optional schräg /direkt/ elliptisch/ kleine Rundlochung

### Precise Control of Light

For kinds of facial rings can be selected to create different light spot atmosphere and outstanding light shape. Optional oblique/ direct/elliptical/small round holes

### • Abstrahlwinkel

Luxx hat 15°, 24°, 38° Abstrahlwinkel nach Wahl, Sie können auch Zubehör zur Entblendung hinzufügen, um Sehkomfort zu schaffen.

### Beam Angle

Luxx has 15°, 24°, 38° beam angle for your choice, you also can add anti-glare accessories to create visual comfort.

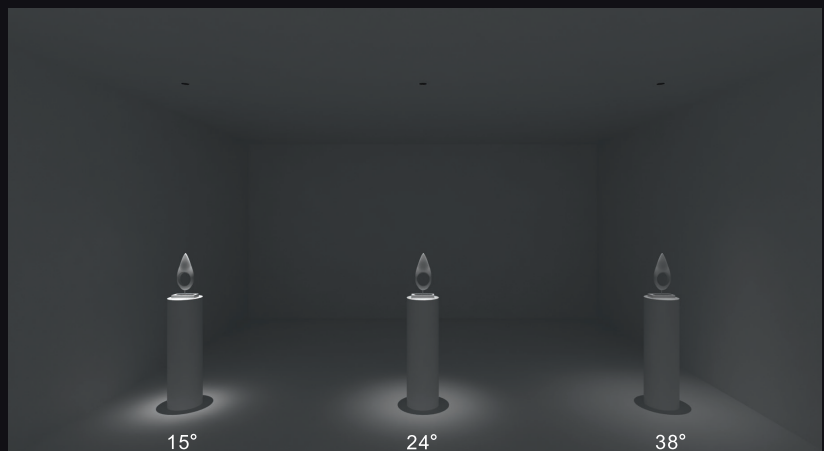

## Anti-blendstruktur/Anti-glare Structure

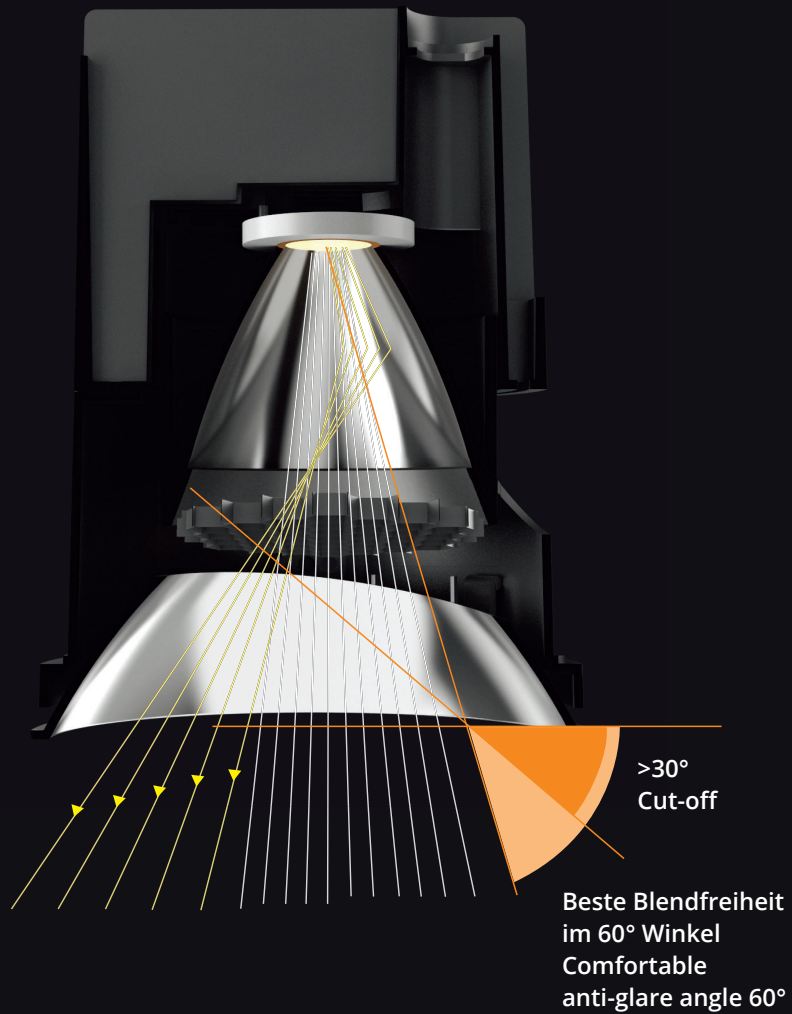

- **Blendfreiheit**

Im blendfreien Winkel gibt es keinen direkten Blick auf die LED und der sichtbare Teil des Reflektors erzeugt praktisch keine Blendung. Diese Zone bietet sehr hohen Sehkomfort.

### Anti-glare

In the glare free angle, there is no direct view of the LED and the visible part of the reflector produces practically no glare at all. This zone offers very high visual comfort.

## Anti Blend Zubehör/Anti-glare Accessory

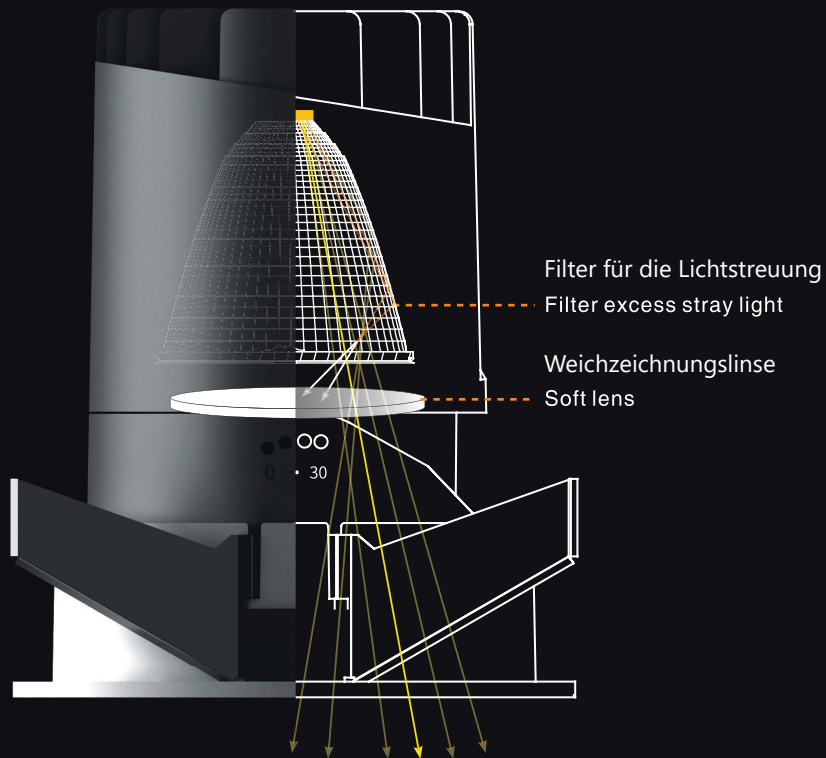

Halb softes Licht  
Medium Soft Light



Rechteckiges Licht  
Rectangular Light



Quadratisches Licht  
Square Light

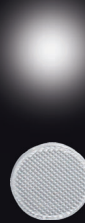

Softes Flutlicht  
Flood Soft light

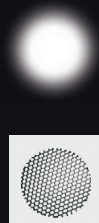

Wabenmuster  
Honeycomb

## Modular Design

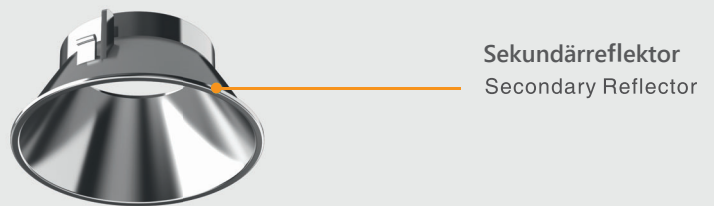
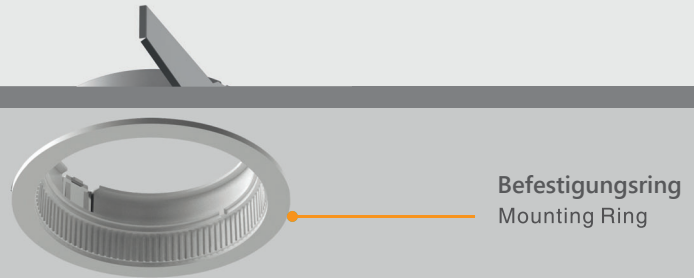

LED-Modul, Montagering und Sekundärreflektor sind modular aufgebaut.

Einfach zu spezifizieren!

Einfache Bestandsführung!

Einfach zu installieren und zu warten!

Einfacher Wechsel des Zweitreflektors!

LED module, Mounting ring and Secondary reflector are modular design.

Easy to specify!

Easy to manage stock!

Easy to install and do maintenance!

Easy to change the Secondary reflector!

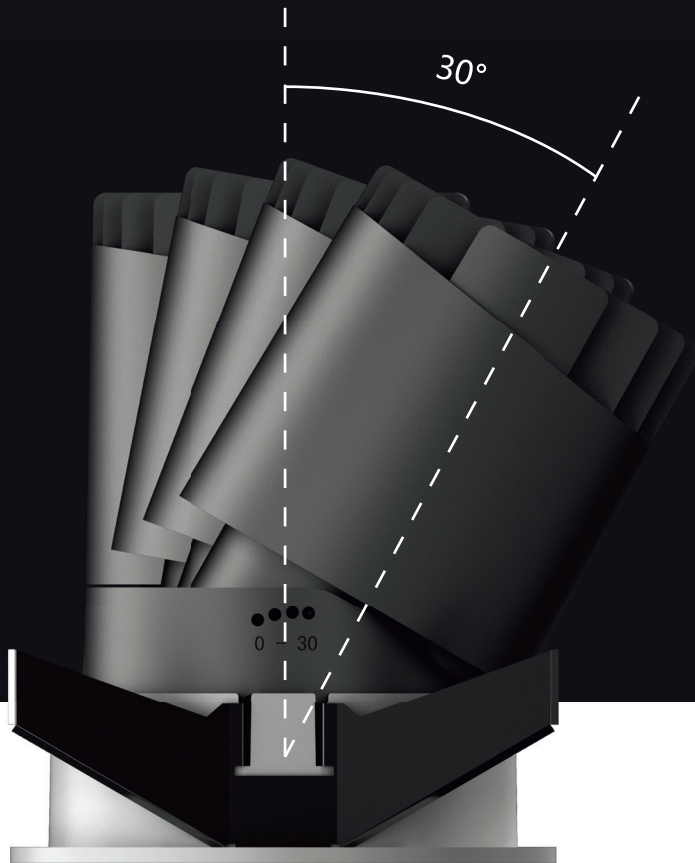

## 30° Neigung/Tilt

Einfache Einstellung auf einen bestimmten Winkel  
dank des präzisen Verstellmechanismus.

Easy to adjust to specific angle  
thanks to precision engineered adjustment mechanism.

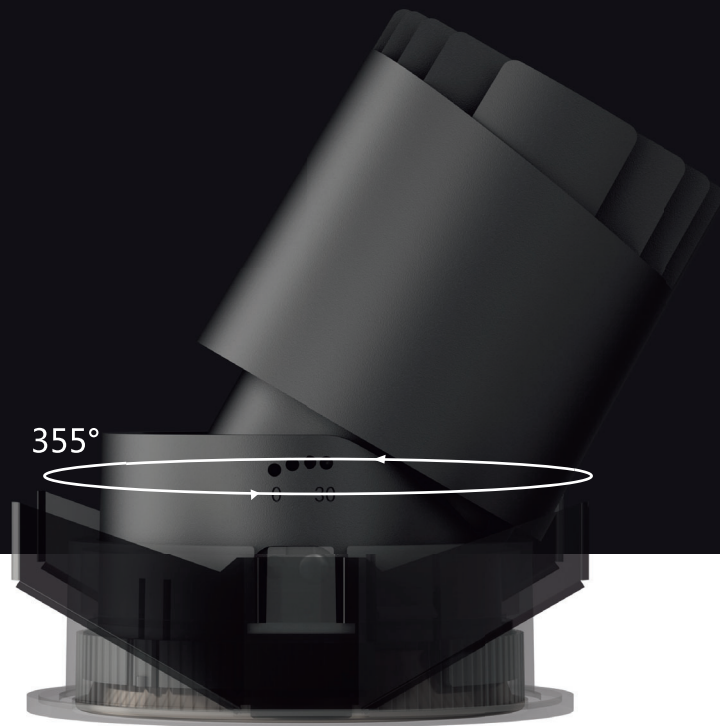

355° Drehung/Rotation

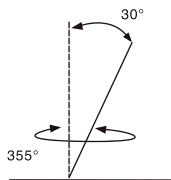
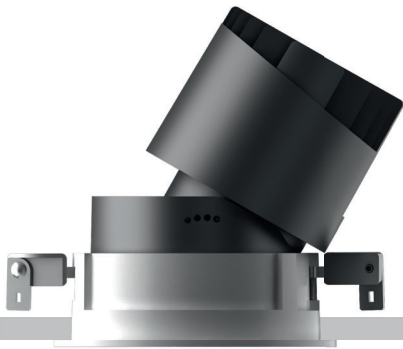

## LUXX

### Round Down Light

#### Rund & verstellbar mit Rand Round Adjustable

Vier Größen mit einer Leistung von 5W-25W.  
355° Drehung und 30° Neigung.

Four sizes with wattage 5W-25W.  
355° rotation and 30° tilt.

#### Rund & verstellbar ohne Rand Round Adjustable Trimless

Lassen Sie Ihren Strahler in der Decke verschwinden.  
355° Drehung und 30° Neigung.

Make your downlight invisible in the ceiling.  
355° rotation and 30° tilt.

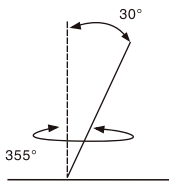
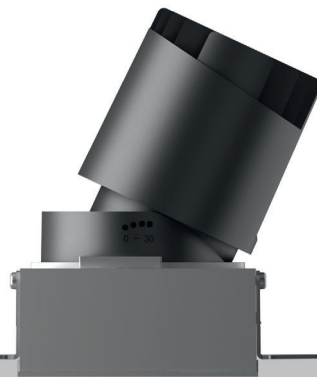
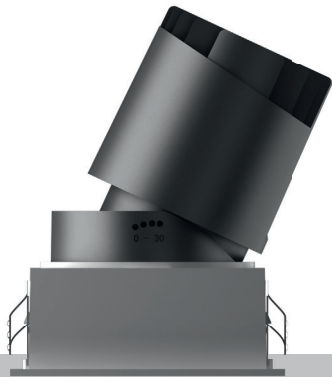

## LUXX

### Square Down Light

(Round Secondary Reflector)

#### Eckig & verstellbar mit Rand Square Adjustable

82x82mm Ausschnitt mit einer Leistung von 10W.  
355° Drehung und 30° Neigung.

82x82mm cut-out with wattage 10W.  
355° rotation and 30° tilt.

#### Eckig & verstellbar ohne Rand Square Adjustable Trimless

Lassen Sie Ihren Strahler in der Decke verschwinden.  
355° Drehung und 30° Neigung.

Make your downlight invisible in the ceiling.  
355° rotation and 30° tilt.

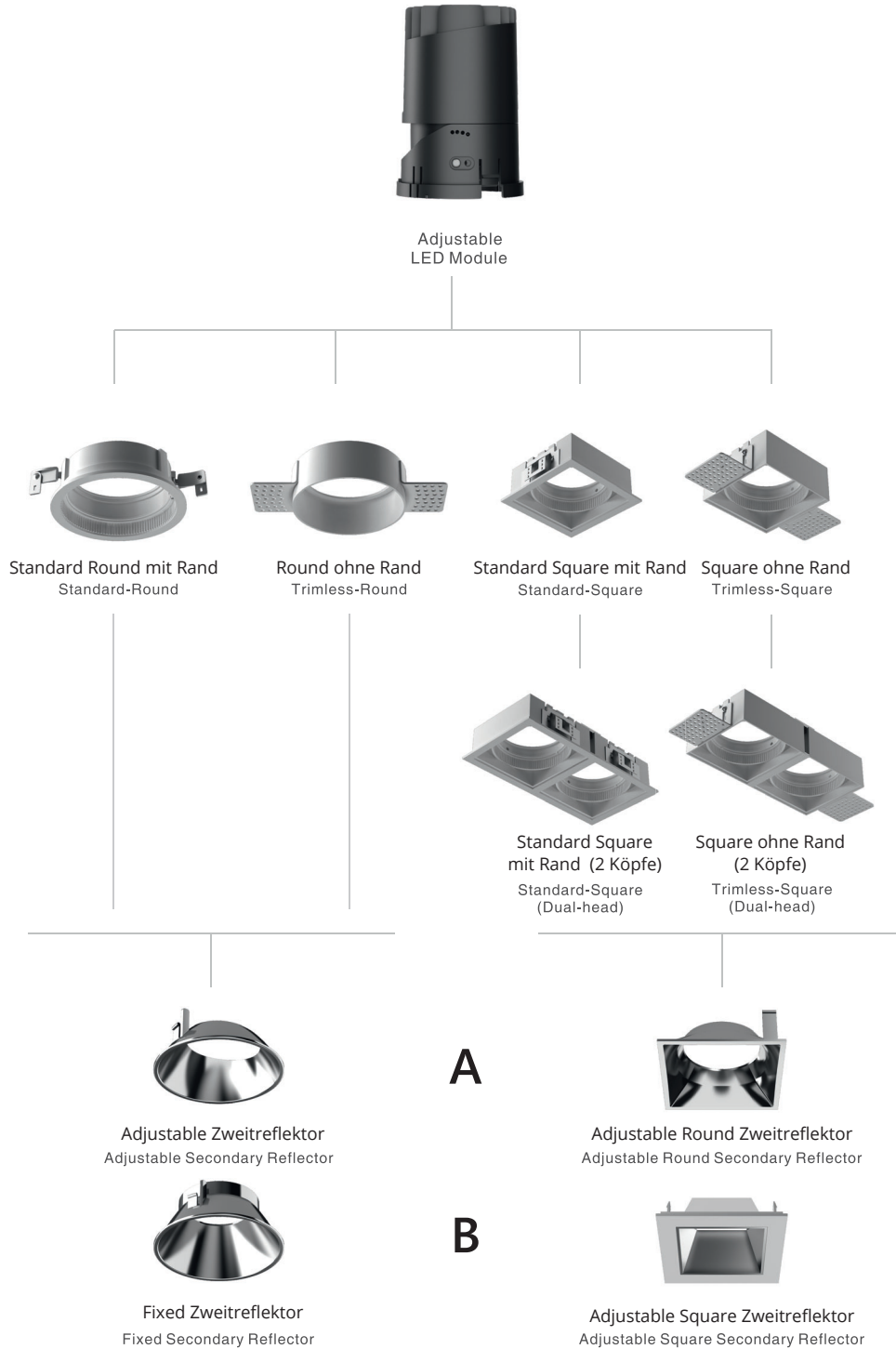

**Zweitreflektor-Farbe/Secondary Reflector Color**



\*Silber ist bei Bestellung immer Standard.  
Anderer Reflektor optional dazubestellbar.  
\*Silver is standard when ordering.  
An other reflector is optional for separat order.



  
Silber  
Silver  
(Standard)



  
Schwarz  
Black



  
Weiß  
White



  
Gold  
Gold



  
Champagner  
Champagne





mit Rand  
Trim

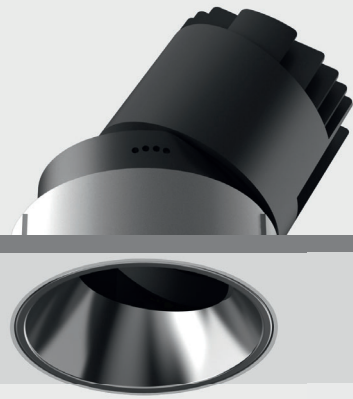

ohne Rand  
Trimless

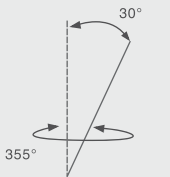

## Round Adjustable (dreh- und schwenkbar)



- Stilvoll elegant, vielseitig in der Anwendung.
- Vollständiges Sortiment an verstellbaren Strahlern mit einer Leistung von 5W-25W in 4 Größen.
- Einfache Einstellung eines bestimmten Winkels durch den präzisen Verstellmechanismus.
- 355° Drehung und 30° Neigung.
- Austauschbare, verschiedenfarbige Sekundärreflektoren für dekorative Blendfreiheit.
- Das Zubehör für Blendfreiheit bietet maximalen Sehkomfort.
- Elegant in its style, versatile in its using.
- Full range of adjustable downlight with wattages 5W-25W in 4 sizes.
- Easy to adjust to specific angle thanks to precision engineered adjustment mechanism.
- 355° rotation and 30° tilt.
- Interchangeable different color secondary reflectors for anti-glare and decorative function.
- Anti-glare accessories provide maximum visual comfort.



50mm



75mm



95mm



120mm

Round Adjustable:



50mm



75mm



95mm



120mm

Round Adjustable:  
ohne Zierrahmen  
Trimless

Cut out:  $\varnothing$ 50mm

Cut out:  $\varnothing$ 75mm

Cut out:  $\varnothing$ 95mm

Cut out:  $\varnothing$ 120mm

# DOWN LIGHT | LUXX | ROUND ADJUSTABLE



50mm

75mm

95mm

120mm

## Rand/Trim (ohne Rand für separate Bestellung/Trimless for separate order)



**Standard**  
mit Rand/Trim

ZB-03014-07  
ZB-03015-07  
ZB-03016-07  
ZB-03017-07



**Option**  
ohne Rand/Trimless

ZB-03018-07  
ZB-03019-07  
ZB-03020-07  
ZB-03021-07

## Zweitreflektor/Secondary Reflector



Silber  
Silver  
(Standard)



Weiß  
White



Schwarz  
Black



Gold  
Gold



Champagner  
Champagne

<b>75mm:</b>	ZB-03024-15	ZB-03024-07	ZB-03024-06	ZB-03024-04	ZB-03024-16
<b>95mm:</b>	ZB-03025-15	ZB-03025-07	ZB-03025-06	ZB-03025-04	ZB-03025-16
<b>120mm:</b>	ZB-03026-15	ZB-03026-07	ZB-03026-06	ZB-03026-04	ZB-03026-16

Standardmäßig werden die Strahler immer mit silbernem Reflektor bestückt (inkl.).  
The spotlights are always equipped with a silver reflector (included).

Dreh- und schwenkbarer Reflektor  
Adjustable reflector

**B**

<b>75mm:</b>	ZB-03027-15	ZB-03027-07	ZB-03027-06	ZB-03027-04	ZB-03027-16
<b>95mm:</b>	ZB-03028-15	ZB-03028-07	ZB-03028-06	ZB-03028-04	ZB-03028-16
<b>120mm:</b>	ZB-03029-15	ZB-03029-07	ZB-03029-06	ZB-03029-04	ZB-03029-16

Starrer Reflektor: Mit Einsatz des Reflektors wird der Strahler fixiert.  
Fix reflector: The spotlight is fixed with this reflector.

## Blendschutzzubehör/Anti-Glare Accessories (Optional)



Wabenmuster  
Honeycomb

**50mm:** ZB-03032  
**75mm:** ZB-03033  
**95mm:** ZB-03034  
**120mm:** ZB-03035



Softes Flutlicht  
Flood soft light

ZB-03036  
ZB-03037  
ZB-03038



Halbsoftes Licht  
Medium soft light

ZB-03039  
ZB-03040  
ZB-03041



Quadratisches Licht  
Square light

ZB-03042  
ZB-03043  
ZB-03044



Rechteckiges Licht  
Rectangular light

ZB-03045  
ZB-03046  
ZB-03047

# ROUND ADJUSTABLE | LUXX | DOWN LIGHT

## Round Adjustable Ø 50mm

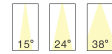
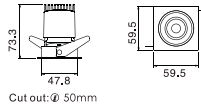

03001-0102		03001-0202		03001-0302																																																							
	<table border="1"> <tr><th>D(cm)</th><th>h(m)</th><th>E(lx)</th></tr> <tr><td>30,38</td><td>1</td><td>171,0</td></tr> <tr><td>60,75</td><td>2</td><td>427,5</td></tr> <tr><td>91,13</td><td>3</td><td>190,0</td></tr> <tr><td>121,50</td><td>4</td><td>106,9</td></tr> <tr><td>151,88</td><td>5</td><td>68,4</td></tr> </table>	D(cm)	h(m)	E(lx)	30,38	1	171,0	60,75	2	427,5	91,13	3	190,0	121,50	4	106,9	151,88	5	68,4		<table border="1"> <tr><th>D(cm)</th><th>h(m)</th><th>E(lx)</th></tr> <tr><td>36,73</td><td>1</td><td>163,4</td></tr> <tr><td>73,46</td><td>2</td><td>408,6</td></tr> <tr><td>110,19</td><td>3</td><td>181,6</td></tr> <tr><td>146,92</td><td>4</td><td>102,2</td></tr> <tr><td>183,65</td><td>5</td><td>65,38</td></tr> </table>	D(cm)	h(m)	E(lx)	36,73	1	163,4	73,46	2	408,6	110,19	3	181,6	146,92	4	102,2	183,65	5	65,38		<table border="1"> <tr><th>D(cm)</th><th>h(m)</th><th>E(lx)</th></tr> <tr><td>51,79</td><td>1</td><td>820,6</td></tr> <tr><td>103,58</td><td>2</td><td>205,2</td></tr> <tr><td>155,36</td><td>3</td><td>91,18</td></tr> <tr><td>207,15</td><td>4</td><td>51,29</td></tr> <tr><td>258,94</td><td>5</td><td>32,82</td></tr> </table>	D(cm)	h(m)	E(lx)	51,79	1	820,6	103,58	2	205,2	155,36	3	91,18	207,15	4	51,29	258,94	5	32,82
D(cm)	h(m)	E(lx)																																																									
30,38	1	171,0																																																									
60,75	2	427,5																																																									
91,13	3	190,0																																																									
121,50	4	106,9																																																									
151,88	5	68,4																																																									
D(cm)	h(m)	E(lx)																																																									
36,73	1	163,4																																																									
73,46	2	408,6																																																									
110,19	3	181,6																																																									
146,92	4	102,2																																																									
183,65	5	65,38																																																									
D(cm)	h(m)	E(lx)																																																									
51,79	1	820,6																																																									
103,58	2	205,2																																																									
155,36	3	91,18																																																									
207,15	4	51,29																																																									
258,94	5	32,82																																																									
Artikel-Nr. Item-No.	Watt	LED Leistung LED Current	Lumen	CRI	Kelvin	Strahlwinkel Beam Angle																																																					
14-03001-0100-06	5 W	120mA	208 lm	90+	2700K	15°																																																					
14-03001-0102-06	5 W	120mA	212 lm	90+	3000K	15°																																																					
14-03001-0200-06	5 W	120mA	247 lm	90+	2700K	24°																																																					
14-03001-0202-06	5 W	120mA	252 lm	90+	3000K	24°																																																					
14-03001-0300-06	5 W	120mA	212 lm	90+	2700K	38°																																																					
14-03001-0302-06	5 W	120mA	217 lm	90+	3000K	38°																																																					

## Round Adjustable Ø 75mm

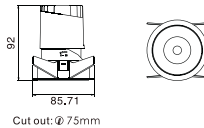

Für eine dimmbare Version hängen Sie hinter die Art.-N. -D  
For a dimmable version attach behind the item-no. -D

03002-0102		03002-0202		03002-0302																																																							
	<table border="1"> <tr><th>D(cm)</th><th>h(m)</th><th>E(lx)</th></tr> <tr><td>31,96</td><td>1</td><td>431,1</td></tr> <tr><td>63,92</td><td>2</td><td>1078</td></tr> <tr><td>95,89</td><td>3</td><td>479</td></tr> <tr><td>127,85</td><td>4</td><td>269,4</td></tr> <tr><td>159,81</td><td>5</td><td>172,4</td></tr> </table>	D(cm)	h(m)	E(lx)	31,96	1	431,1	63,92	2	1078	95,89	3	479	127,85	4	269,4	159,81	5	172,4		<table border="1"> <tr><th>D(cm)</th><th>h(m)</th><th>E(lx)</th></tr> <tr><td>41,1</td><td>1</td><td>352,6</td></tr> <tr><td>82,2</td><td>2</td><td>881,6</td></tr> <tr><td>123,31</td><td>3</td><td>391,8</td></tr> <tr><td>164,4</td><td>4</td><td>220,4</td></tr> <tr><td>205,51</td><td>5</td><td>141,1</td></tr> </table>	D(cm)	h(m)	E(lx)	41,1	1	352,6	82,2	2	881,6	123,31	3	391,8	164,4	4	220,4	205,51	5	141,1		<table border="1"> <tr><th>D(cm)</th><th>h(m)</th><th>E(lx)</th></tr> <tr><td>63,44</td><td>1</td><td>2000</td></tr> <tr><td>126,89</td><td>2</td><td>500,1</td></tr> <tr><td>190,33</td><td>3</td><td>222,3</td></tr> <tr><td>253,77</td><td>4</td><td>125</td></tr> <tr><td>317,22</td><td>5</td><td>80,01</td></tr> </table>	D(cm)	h(m)	E(lx)	63,44	1	2000	126,89	2	500,1	190,33	3	222,3	253,77	4	125	317,22	5	80,01
D(cm)	h(m)	E(lx)																																																									
31,96	1	431,1																																																									
63,92	2	1078																																																									
95,89	3	479																																																									
127,85	4	269,4																																																									
159,81	5	172,4																																																									
D(cm)	h(m)	E(lx)																																																									
41,1	1	352,6																																																									
82,2	2	881,6																																																									
123,31	3	391,8																																																									
164,4	4	220,4																																																									
205,51	5	141,1																																																									
D(cm)	h(m)	E(lx)																																																									
63,44	1	2000																																																									
126,89	2	500,1																																																									
190,33	3	222,3																																																									
253,77	4	125																																																									
317,22	5	80,01																																																									
Artikel-Nr. Item-No.	Watt	LED Leistung LED Current	Lumen	CRI	Kelvin	Strahlwinkel Beam Angle																																																					
14-03002-0100-06	10 W	250mA	544 lm	90+	2700K	15°																																																					
14-03002-0102-06	10 W	250mA	555 lm	90+	3000K	15°																																																					
14-03002-0200-06	10 W	250mA	548 lm	90+	2700K	24°																																																					
14-03002-0202-06	10 W	250mA	559 lm	90+	3000K	24°																																																					
14-03002-0300-06	10 W	250mA	554 lm	90+	2700K	38°																																																					
14-03002-0302-06	10 W	250mA	565 lm	90+	3000K	38°																																																					

# DOWN LIGHT | LUXX | ROUND ADJUSTABLE

## Round Adjustable Ø 95mm

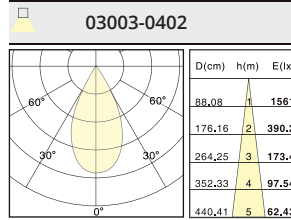
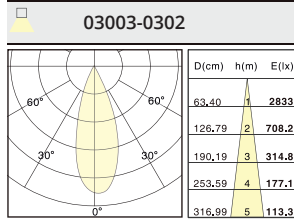
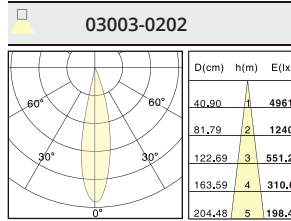
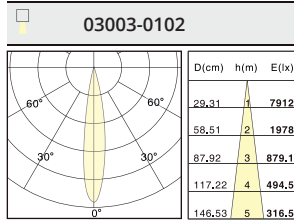
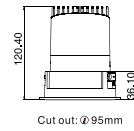

Für eine dimmbare Version hängen Sie hinter die Art.-N. -D

For a dimmable version attach behind the item-no. -D

Artikel-Nr. Item-No.	Watt	LED Leistung LED Current	Lumen	CRI	Kelvin	Strahlwinkel Beam Angle
14-03003-0100-06	18 W	450mA	1068 lm	90+	2700K	15°
14-03003-0102-06	18 W	450mA	1124 lm	90+	3000K	15°
14-03003-0200-06	18 W	450mA	1015 lm	90+	2700K	24°
14-03003-0202-06	18 W	450mA	1069 lm	90+	3000K	24°
14-03003-0300-06	18 W	450mA	994 lm	90+	2700K	38°
14-03003-0302-06	18 W	450mA	1046 lm	90+	3000K	38°
14-03003-0400-06	18 W	450mA	921 lm	90+	2700K	60°
14-03003-0402-06	18 W	450mA	970 lm	90+	3000K	60°

## Round Adjustable Ø 120mm



Für eine dimmbare Version hängen Sie hinter die Art.-N. -D  
For a dimmable version attach behind the item-no. -D

Preis\* €  
Price\* €  
+30,-  
+30,-

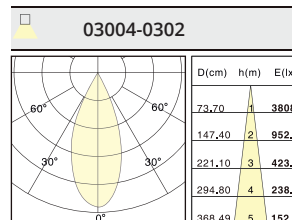
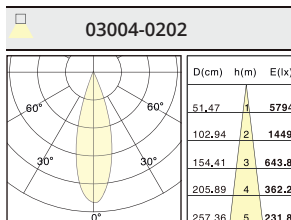
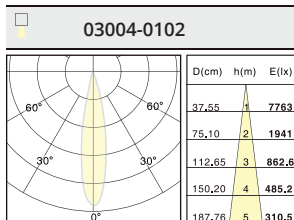
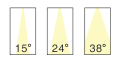
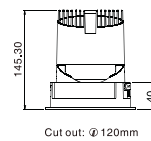

Artikel-Nr. Item-No.	Watt	LED Leistung LED Current	Lumen	CRI	Kelvin	Strahlwinkel Beam Angle
14-03004-0100-06	25 W	700mA	1503 lm	90+	2700K	15°
14-03004-0102-06	25 W	700mA	1534 lm	90+	3000K	15°
14-03004-0200-06	25 W	700mA	1482 lm	90+	2700K	24°
14-03004-0202-06	25 W	700mA	1512 lm	90+	3000K	24°
14-03004-0300-06	25 W	700mA	1561 lm	90+	2700K	38°
14-03004-0302-06	25 W	700mA	1592 lm	90+	3000K	38°



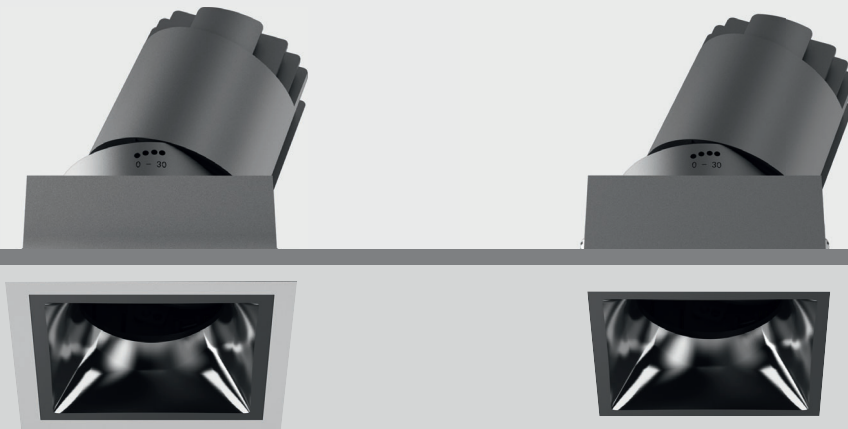

mit Rand/Trim

ohne Rand/Trimless

Round Secondary Reflector

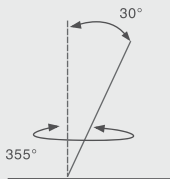

## Square Adjustable (dreh- und schwenkbar)



- Stilvoll elegant, vielseitig in der Anwendung.
- Mehrfachköpfe erhältlich durch ein clever durchdachtes Design.
- Einfache Einstellung eines bestimmten Winkels durch den präzisen Verstellmechanismus.
- 355° Drehung und 30° Neigung.
- Austauschbare, verschiedenfarbige Sekundärreflektoren für dekorative Blendfreiheit.
- Das Zubehör für Blendfreiheit bietet maximalen Sehkomfort.
- Elegant in its style, versatile in its using.
- Multihead is available thanks to a smart mechanical design.
- Easy to adjust to specific angle thanks to precision engineered adjustment mechanism.
- 355° rotation and 30° tilt.
- Interchangeable different color secondary reflectors for anti-glare and decorative function.
- Anti-glare accessories provide maximum visual comfort.

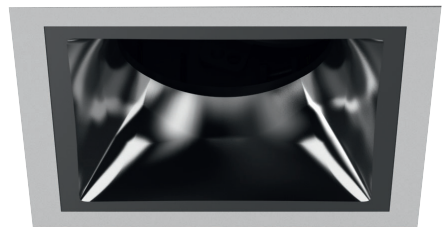

**Round Reflector**

Cut out:  $\varnothing$  82\*82mm

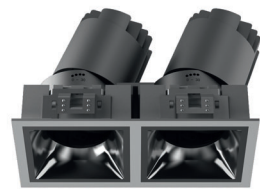

**Round Reflector Double**

Cut out:  $\varnothing$  163\*82mm

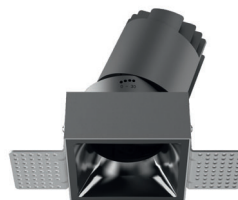

**Round Reflector  
ohne Zierrahmen/Trimless**

Cut out:  $\varnothing$  82\*82mm



**Round Reflector Double  
ohne Zierrahmen/Trimless**

Cut out:  $\varnothing$  163\*82mm



Square Adjustable  
Round Reflector  
82mm

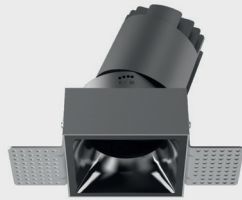

Square Adjustable Trimless  
Round Reflector  
82mm

**Rand/Trim** (ohne Rand für separate Bestellung/Trimless for separate order)

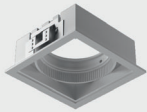

**Standard**  
mit Rand/Trim

ZB-03022-07

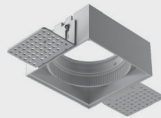

**Option**  
ohne Rand/Trimless

ZB-03023-07

**Zweitreflektor/Secondary Reflector**

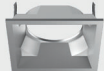

Silber  
Silver  
(Standard)  
ZB-03030-15



Weiß  
White  
ZB-03030-07



Schwarz  
Black  
ZB-03030-06



Gold  
Gold  
ZB-03030-04



Champagner  
Champagne  
ZB-03030-16

Standardmäßig werden die Strahler immer mit silbernem Reflektor bestückt (inkl.).  
The spotlights are always equipped with a silver reflector (included).

**Blendschutzzubehör/Anti-Glare Accessories (Optional)**



Wabenmuster  
Honeycomb

Single: ZB-03048  
Double: ZB-03053



Softes Flutlicht  
Flood soft light

ZB-03049  
ZB-03054



Halbsoftes Licht  
Medium soft light

ZB-03050  
ZB-03055



Quadratisches Licht  
Square light

ZB-03051  
ZB-03056



Rechteckiges Licht  
Rectangular light

ZB-03052  
ZB-03057

Square Adjustable Single

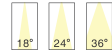
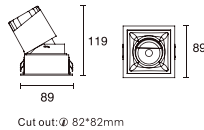

Für eine dimmbare Version hängen Sie hinter die Art.-N. -D  
For a dimmable version attach behind the item-no. -D

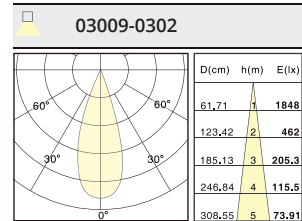
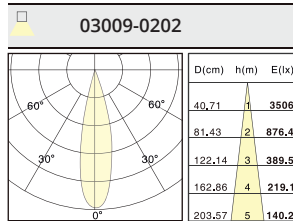
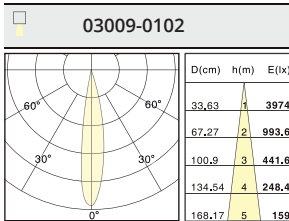

Artikel-Nr. Item-No.	Watt	LED Leistung LED Current	Lumen	CRI	Kelvin	Strahlwinkel Beam Angle
14-03009-0100-06	10 W	120mA	547 lm	90+	2700K	18°
14-03009-0102-06	10 W	120mA	558 lm	90+	3000K	18°
14-03009-0200-06	10 W	120mA	571 lm	90+	2700K	24°
14-03009-0202-06	10 W	120mA	583 lm	90+	3000K	24°
14-03009-0300-06	10 W	120mA	537 lm	90+	2700K	36°
14-03009-0302-06	10 W	120mA	548 lm	90+	3000K	36°

Square Adjustable Double

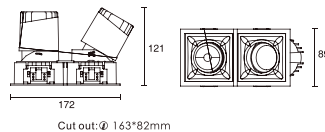

Für eine dimmbare Version hängen Sie hinter die Art.-N. -D  
For a dimmable version attach behind the item-no. -D

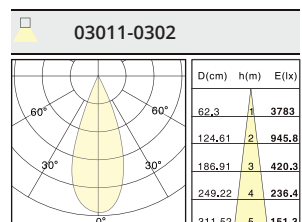
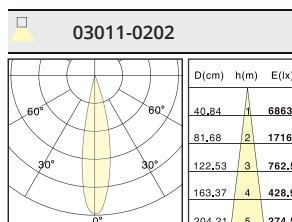
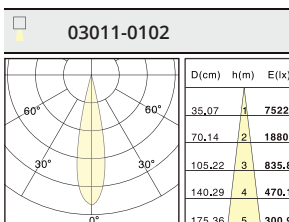

Artikel-Nr. Item-No.	Watt	LED Leistung LED Current	Lumen	CRI	Kelvin	Strahlwinkel Beam Angle
14-03011-0100-06	10W×2	250mA	1143 lm	90+	2700K	18°
14-03011-0102-06	10W×2	250mA	1166 lm	90+	3000K	18°
14-03011-0200-06	10W×2	250mA	1183 lm	90+	2700K	24°
14-03011-0202-06	10W×2	250mA	1207 lm	90+	3000K	24°
14-03011-0300-06	10W×2	250mA	1148 lm	90+	2700K	36°
14-03011-0302-06	10W×2	250mA	1172 lm	90+	3000K	36°

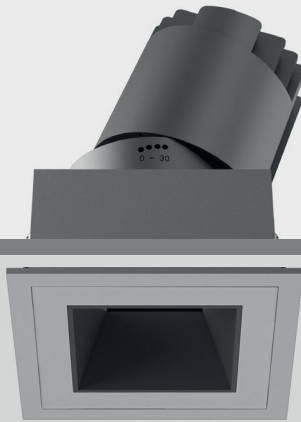

mit Rand/Trim



ohne Rand/Trimless

### Square Secondary Reflector

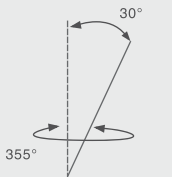

## Square Adjustable (dreh- und schwenkbar)



- Stilvoll elegant, vielseitig in der Anwendung.
- Mehrfachköpfe erhältlich dank eines clever durchdachten Designs.
- Einfache Einstellung eines bestimmten Winkels durch den präzisen Verstellmechanismus.
- 355° Drehung und 30° Neigung.
- Austauschbare, verschiedenfarbige Sekundärreflektoren für dekorative Blendfreiheit.
- Das Zubehör für Blendfreiheit bietet maximalen Sehkomfort.
- Elegant in its style, versatile in its using.
- Multihead is available thanks to a smart mechanical design.
- Easy to adjust to specific angle thanks to precision engineered adjustment mechanism.
- 355° rotation and 30° tilt.
- Interchangeable different color secondary reflectors for anti-glare and decorative function.
- Anti-glare accessories provide maximum visual comfort.



**Square Reflector**

Cut out:  $\varnothing$  82\*82mm



**Square Reflector Double**

Cut out:  $\varnothing$  163\*82mm

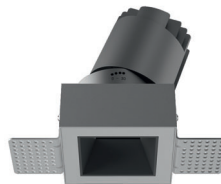

**Square Reflector  
ohne Zierrahmen/Trimless**

Cut out:  $\varnothing$  82\*82mm



**Square Reflector Double  
ohne Zierrahmen/Trimless**

Cut out:  $\varnothing$  163\*82mm

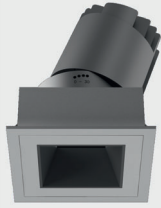

Square Adjustable  
Square Reflector  
82mm

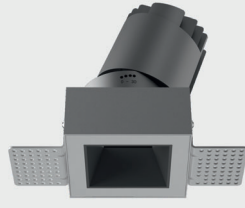

Square Adjustable Trimless  
Square Reflector  
82mm

**Rand/Trim** (ohne Rand für separate Bestellung/Trimless for separate order)

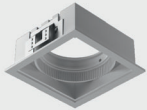

**Standard**  
mit Rand/Trim

ZB-03022-07

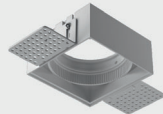

**Option**  
ohne Rand/Trimless

ZB-03023-07

**Zweitreflektor/Secondary Reflector**

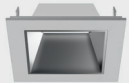

Silber  
Silver  
(Standard)

ZB-03031-15



Weiß  
White

ZB-03031-07



Schwarz  
Black

ZB-03031-06

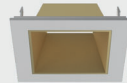

Gold  
Gold

ZB-03031-04

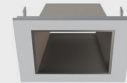

Champagner  
Champagne

ZB-03031-16

Standardmäßig werden die Strahler immer mit silbernem Reflektor bestückt (inkl.).  
The spotlights are always equipped with a silver reflector (included).

**Blendschutzzubehör/Anti-Glare Accessories (Optional)**



Wabenmuster  
Honeycomb

Single: ZB-03048

Double: ZB-03053



Softes Flutlicht  
Flood soft light

ZB-03049

ZB-03054



Halbsoftes Licht  
Medium soft light

ZB-03050

ZB-03055



Quadratisches Licht  
Square light

ZB-03051

ZB-03056



Rechteckiges Licht  
Rectangular light

ZB-03052

ZB-03057

Square Adjustable Single

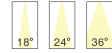
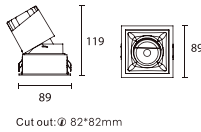

Für eine dimmbare Version hängen Sie hinter die Art.-N. -D  
For a dimmable version attach behind the item-no. -D

03010-0102		03010-0202		03010-0302	
D(cm)	h(m)	E(lx)	D(cm)	h(m)	E(lx)
33,81	1	3841	39,24	1	3362
67,63	2	960,2	78,49	2	840,6
101,44	3	426,8	117,73	3	373,6
135,26	4	240,1	156,98	4	210,1
169,07	5	153,6	196,22	5	134,5
55,79	1	2004	111,59	2	500,9
167,38	3	222,6	223,18	4	125,2
278,97	5	80,15			

Artikel-Nr. Item-No.	Watt	LED Leistung LED Current	Lumen	CRI	Kelvin	Strahlwinkel Beam Angle
14-03010-0100-06	10 W	120mA	480 lm	90+	2700K	18°
14-03010-0102-06	10 W	120mA	490 lm	90+	3000K	18°
14-03010-0200-06	10 W	120mA	499 lm	90+	2700K	24°
14-03010-0202-06	10 W	120mA	509 lm	90+	3000K	24°
14-03010-0300-06	10 W	120mA	529 lm	90+	2700K	36°
14-03010-0302-06	10 W	120mA	540 lm	90+	3000K	36°

Square Adjustable Double

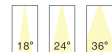
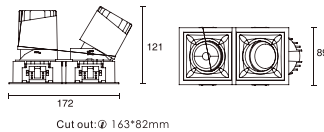

Für eine dimmbare Version hängen Sie hinter die Art.-N. -D  
For a dimmable version attach behind the item-no. -D

03012-0102		03012-0202		03012-0302	
D(cm)	h(m)	E(lx)	D(cm)	h(m)	E(lx)
67,72	1	7682	78,48	1	6724
135,26	2	1920,4	156,98	2	1681,2
202,88	3	853,6	235,46	3	747,2
270,52	4	480,2	313,96	4	420,2
338,14	5	307,2	392,44	5	269
111,58	1	4008	223,18	2	1001,8
334,76	3	445,2	446,36	4	250,4
557,94	5	160,3			

Artikel-Nr. Item-No.	Watt	LED Leistung LED Current	Lumen	CRI	Kelvin	Strahlwinkel Beam Angle
14-03012-0100-06	10W×2	250mA	966 lm	90+	2700K	18°
14-03012-0102-06	10W×2	250mA	985 lm	90+	3000K	18°
14-03012-0200-06	10W×2	250mA	1004 lm	90+	2700K	24°
14-03012-0202-06	10W×2	250mA	1025 lm	90+	3000K	24°
14-03012-0300-06	10W×2	250mA	1070 lm	90+	2700K	36°
14-03012-0302-06	10W×2	250mA	1092 lm	90+	3000K	36°

DOWN LIGHT | LUXX

# Square Adjustable Multihead

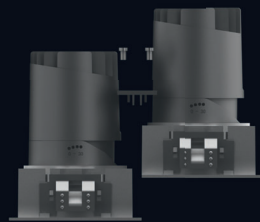

1+1+1.....

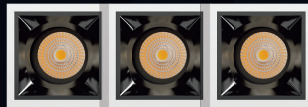
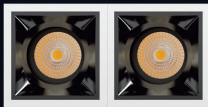

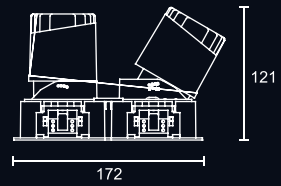
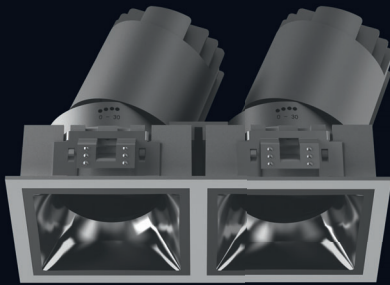

Ø163x82mm

**Square Adjustable Double**

Cut-out: Ø163x82(W)mm  
 Size: Ø172x89(W)x121(H)mm

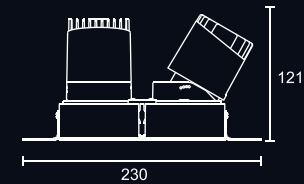
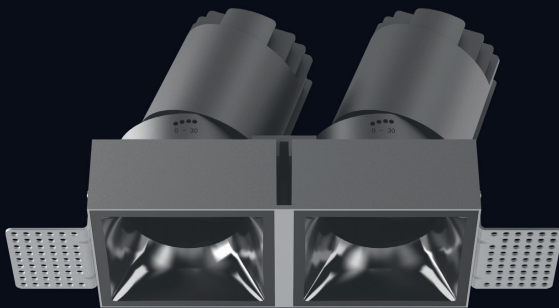

Ø163x82mm

**Square Adjustable Double Trimless**

Cut-out: Ø163x82(W)mm  
 Size: Ø172x89(W)x121(H)mm

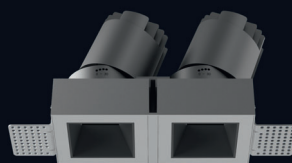
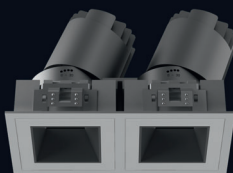



powered by Top Light GmbH & Co. KG  
Industriezentrum 100  
32139 Spenge

fon +49 (0) 52 25 . 8 63 12 - 0  
fax +49 (0) 52 25 . 8 63 12 - 10

[www.orange-one.de](http://www.orange-one.de)  
[brief@orange-one.de](mailto:brief@orange-one.de)